

# WTR04N065L-HAF

## N-Channel Enhancement Mode MOSFET

### Features

- Low Gate Charge
- Halogen and Antimony Free(HAF), RoHS compliant

### Applications

- synchronous buck converter

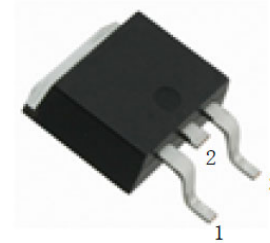
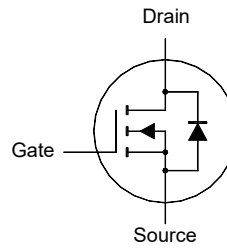

1.Gate 2.Drain 3.Source  
TO-252 Plastic Package

### Key Parameters

Parameter	Value	Unit
$BV_{DSS}$	40	V
$R_{DS(ON)}$ Max	6.5 @ $V_{GS} = 10$ V	m $\Omega$
	8 @ $V_{GS} = 4.5$ V	
$V_{GS(th)}$ typ	1.4	V
$Q_g$ typ	58 @ $V_{GS} = 10$ V	nC

### Absolute Maximum Ratings(at $T_a = 25^\circ\text{C}$ unless otherwise specified)

Parameter	Symbol	Value	Unit	
Drain-Source Voltage	$V_{DS}$	40	V	
Gate-Source Voltage	$V_{GS}$	$\pm 20$	V	
Drain Current - Continuous	$I_D$	$T_c = 25^\circ\text{C}$	64	A
		$T_c = 100^\circ\text{C}$	40	A
Peak Drain Current, Pulsed <sup>1)</sup>	$I_{DM}$	240	A	
Single-Pulse Avalanche Current	$I_{AS}$	34.3	A	
Single-Pulse Avalanche Energy <sup>2)</sup>	$E_{AS}$	58.8	mJ	
Power Dissipation	$P_D$	43.5	W	
Operating Junction and Storage Temperature Range	$T_j, T_{stg}$	- 55 to + 150	$^\circ\text{C}$	

### Thermal Characteristics

Parameter	Symbol	Max.	Unit
Thermal Resistance from Junction to Case	$R_{\theta JC}$	2.8	$^\circ\text{C/W}$
Thermal Resistance from Junction to Ambient <sup>3)</sup>	$R_{\theta JA}$	35	$^\circ\text{C/W}$

<sup>1)</sup> Pulse Test: Pulse Width  $\leq 100$   $\mu\text{s}$ , Duty Cycle  $\leq 2\%$ , Repetitive rating, pulse width limited by junction temperature  $T_{J(MAX)} = 150^\circ\text{C}$ .

<sup>2)</sup> Limited by  $T_{J(MAX)}$ , starting  $T_j = 25^\circ\text{C}$ ,  $L = 0.1$  mH,  $R_g = 25$   $\Omega$ ,  $I_{AS} = 34.3$  A,  $V_{GS} = 10$  V.

<sup>3)</sup> Device mounted on FR-4 substrate PC board, 2oz copper, with 1-inch square copper plate in still air.

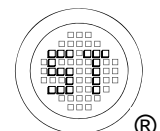

# WTR04N065L-HAF

Characteristics at  $T_a = 25^\circ\text{C}$  unless otherwise specified

Parameter	Symbol	Min.	Typ.	Max.	Unit
<b>STATIC PARAMETERS</b>					
Drain-Source Breakdown Voltage at $I_D = 250 \mu\text{A}$	$BV_{DSS}$	40	-	-	V
Drain-Source Leakage Current at $V_{DS} = 32 \text{ V}$	$I_{DSS}$	-	-	1	$\mu\text{A}$
Gate-Source Leakage Current at $V_{GS} = \pm 20 \text{ V}$	$I_{GSS}$	-	-	$\pm 100$	nA
Gate-Source Threshold Voltage at $V_{DS} = V_{GS}$ , $I_D = 250 \mu\text{A}$	$V_{GS(th)}$	1	-	2.5	V
Drain-Source On-State Resistance at $V_{GS} = 10 \text{ V}$ , $I_D = 10 \text{ A}$ at $V_{GS} = 4.5 \text{ V}$ , $I_D = 5 \text{ A}$	$R_{DS(on)}$	- -	4.7 -	6.5 8	$\text{m}\Omega$
<b>DYNAMIC PARAMETERS</b>					
Forward Transconductance at $V_{DS} = 5 \text{ V}$ , $I_D = 5 \text{ A}$	$g_{FS}$	-	21.8	-	S
Gate Resistance at $V_{DS} = 0 \text{ V}$ , $V_{GS} = 0 \text{ V}$ , $f = 1 \text{ MHz}$	$R_g$	-	0.5	-	$\Omega$
Input Capacitance at $V_{GS} = 0 \text{ V}$ , $V_{DS} = 20 \text{ V}$ , $f = 1 \text{ MHz}$	$C_{iss}$	-	3197	-	pF
Output Capacitance at $V_{GS} = 0 \text{ V}$ , $V_{DS} = 20 \text{ V}$ , $f = 1 \text{ MHz}$	$C_{oss}$	-	243	-	pF
Reverse Transfer Capacitance at $V_{GS} = 0 \text{ V}$ , $V_{DS} = 20 \text{ V}$ , $f = 1 \text{ MHz}$	$C_{rss}$	-	146	-	pF
Gate Charge Total at $V_{DS} = 20 \text{ V}$ , $V_{GS} = 10 \text{ V}$ , $I_D = 10 \text{ A}$ at $V_{DS} = 20 \text{ V}$ , $V_{GS} = 4.5 \text{ V}$ , $I_D = 10 \text{ A}$	$Q_g$	- -	58 27	- -	nC
Gate to Source Charge at $V_{DS} = 20 \text{ V}$ , $V_{GS} = 10 \text{ V}$ , $I_D = 10 \text{ A}$	$Q_{gs}$	-	9	-	nC
Gate to Drain Charge at $V_{DS} = 20 \text{ V}$ , $V_{GS} = 10 \text{ V}$ , $I_D = 10 \text{ A}$	$Q_{gd}$	-	9	-	nC
Turn-On Delay Time at $V_{GS} = 10 \text{ V}$ , $V_{DS} = 20 \text{ V}$ , $I_D = 10 \text{ A}$ , $R_G = 3.3 \Omega$	$t_{d(on)}$	-	21	-	ns
Turn-On Rise Time at $V_{GS} = 10 \text{ V}$ , $V_{DS} = 20 \text{ V}$ , $I_D = 10 \text{ A}$ , $R_G = 3.3 \Omega$	$t_r$	-	21	-	ns
Turn-Off Delay Time at $V_{GS} = 10 \text{ V}$ , $V_{DS} = 20 \text{ V}$ , $I_D = 10 \text{ A}$ , $R_G = 3.3 \Omega$	$t_{d(off)}$	-	19	-	ns
Turn-Off Fall Time at $V_{GS} = 10 \text{ V}$ , $V_{DS} = 20 \text{ V}$ , $I_D = 10 \text{ A}$ , $R_G = 3.3 \Omega$	$t_f$	-	2.7	-	ns
<b>Body-Diode PARAMETERS</b>					
Drain-Source Diode Forward Voltage at $I_S = 1 \text{ A}$ , $V_{GS} = 0 \text{ V}$	$V_{SD}$	-	-	1	V
Body-Diode Continuous Current	$I_S$	-	-	64	A
Body-Diode Continuous Current, Pulsed	$I_{SM}$	-	-	240	A
Body Diode Reverse Recovery Time at $I_S = 10 \text{ A}$ , $di/dt = 100 \text{ A} / \mu\text{s}$	$t_{rr}$	-	13.8	-	ns
Body Diode Reverse Recovery Charge at $I_S = 10 \text{ A}$ , $di/dt = 100 \text{ A} / \mu\text{s}$	$Q_{rr}$	-	5.6	-	nC

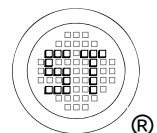

## Electrical Characteristics Curves

Fig. 1 Typical Output Characteristics

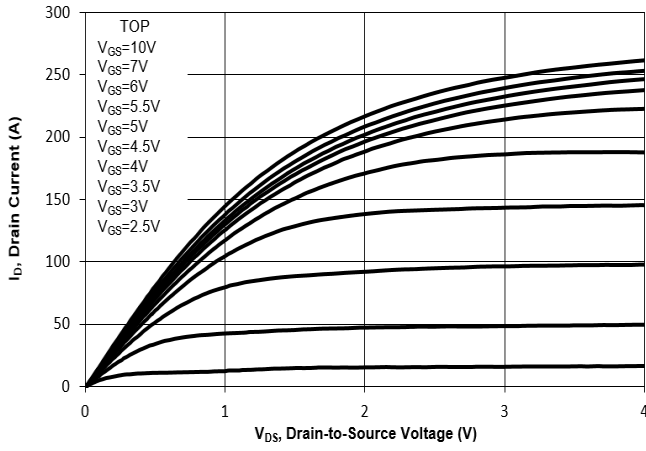

Fig. 2 Typical Transfer Characteristics

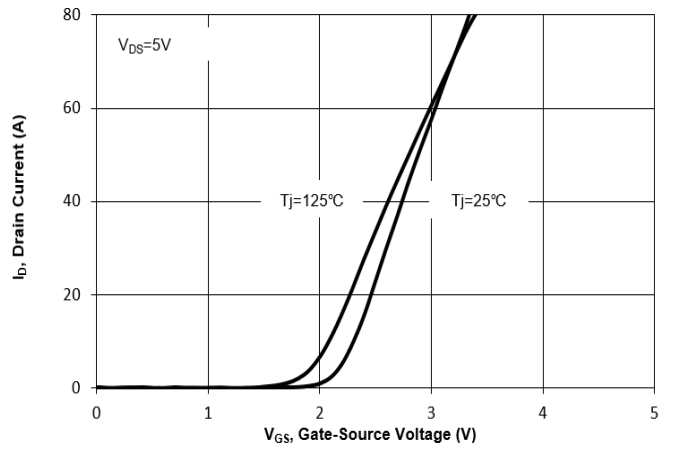

Fig. 3 On-Resistance vs. Drain Current

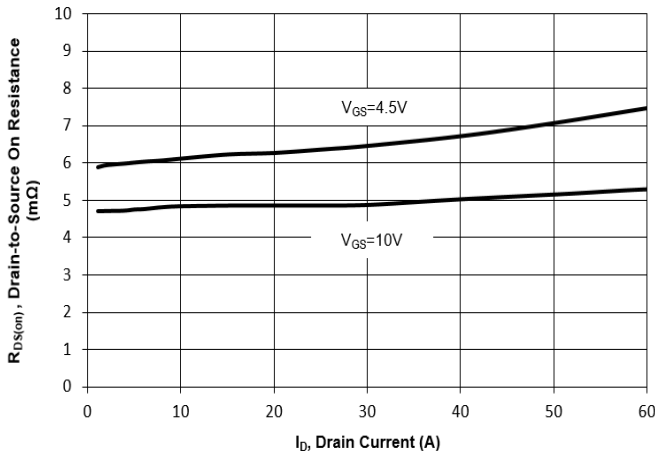

Fig. 4 On-Resistance vs. Gate to Source Voltage

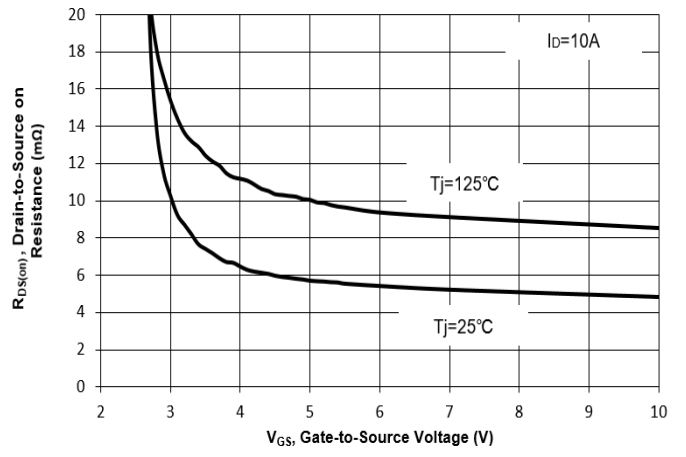

Fig. 5 On-Resistance vs. Tj

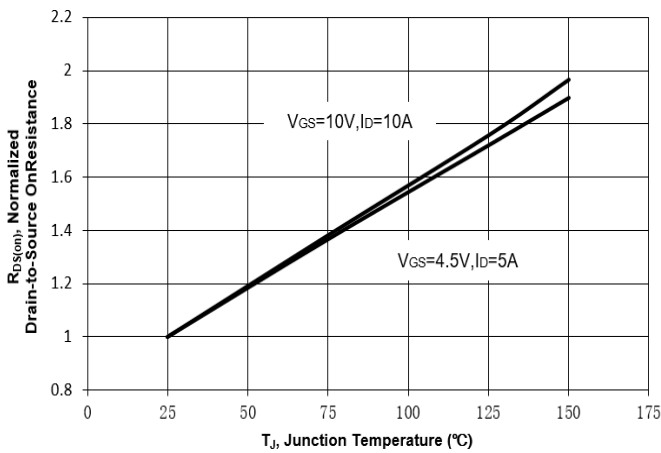
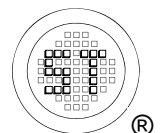
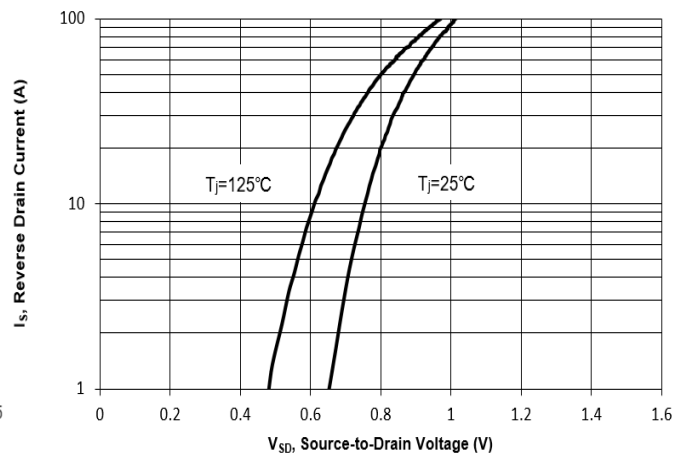

Fig. 6 Typical Body-Diode Forward Characteristics



## Electrical Characteristics Curves

Fig. 7 Typical Junction Capacitance

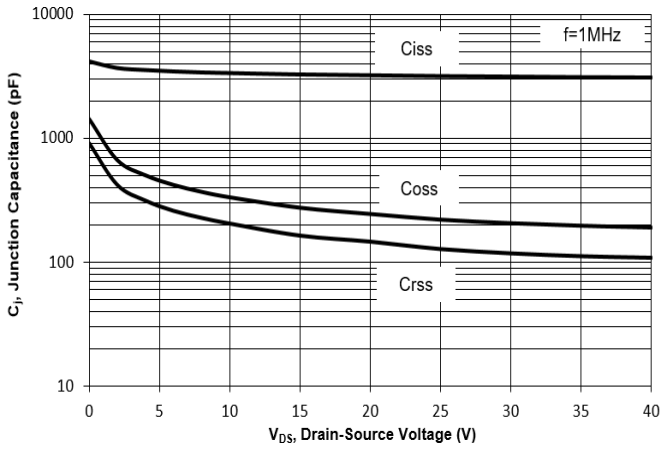

Fig. 8 Drain-Source Leakage Current vs. T<sub>J</sub>

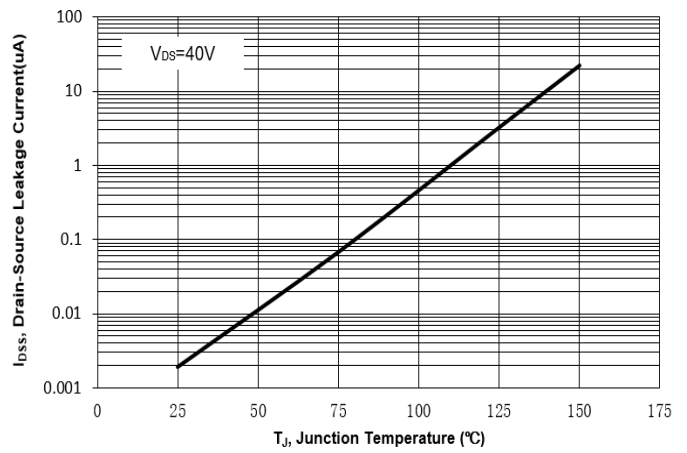

Fig. 9 V<sub>(BR)DSS</sub> vs. Junction Temperature

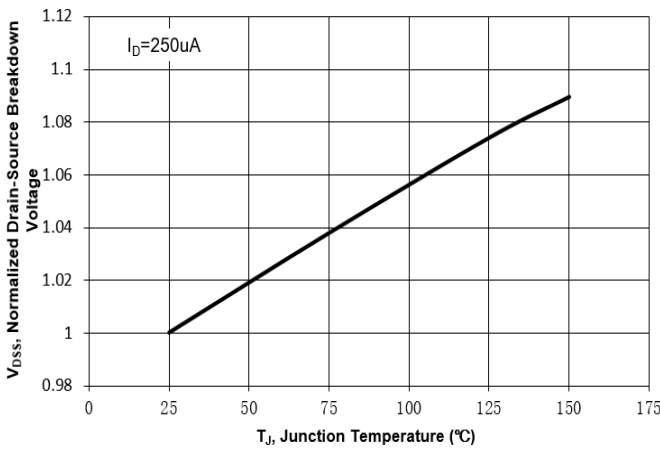

Fig. 10 Gate Threshold Variation vs. T<sub>J</sub>

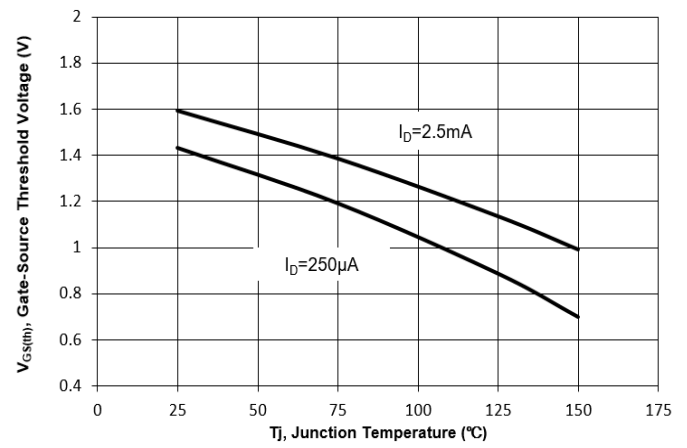

Fig. 11 Gate Charge

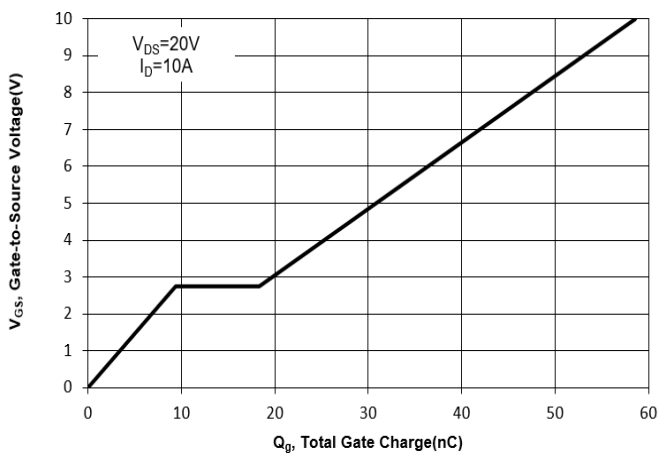
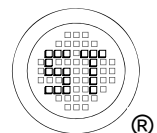
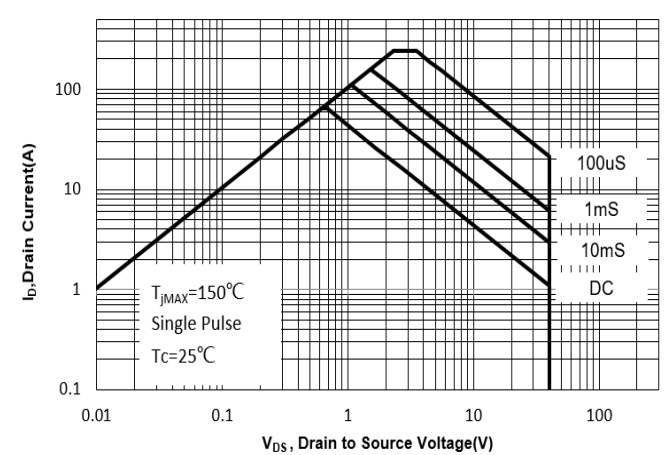

Fig. 12 Safe Operation Area



# WTR04N065L-HAF

## Electrical Characteristics Curves

Fig.13 Normalized Maximum Transient Thermal Impedance( $Z_{\theta JC}$ )

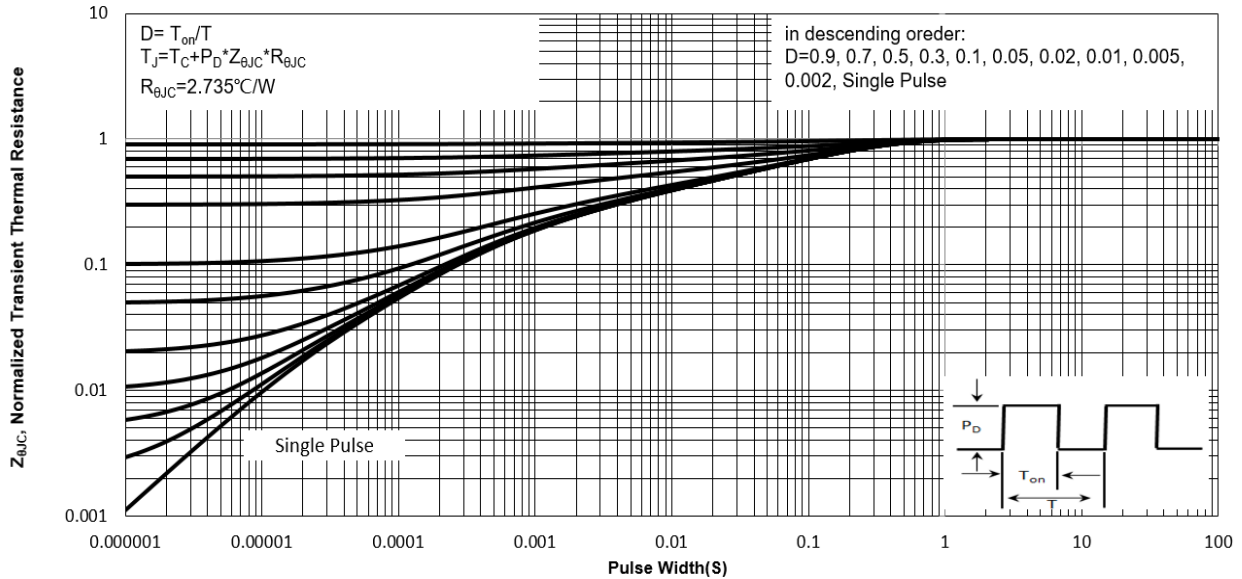
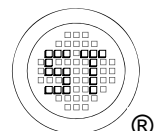
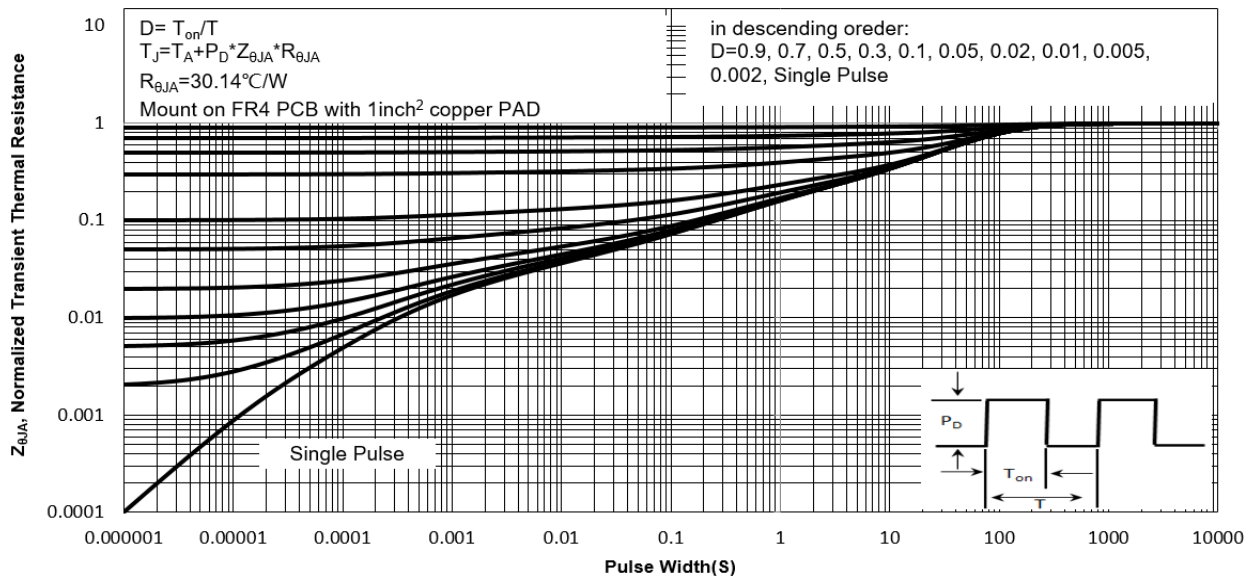

Fig.14 Normalized Maximum Transient Thermal Impedance( $Z_{\theta JA}$ )



## Test Circuits

Fig.1-1 Switching times test circuit

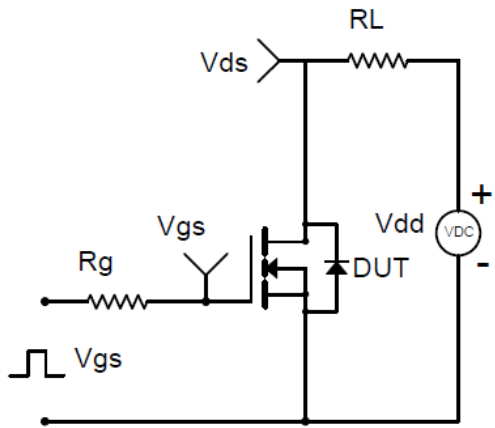

Fig.1-2 Switching Waveform

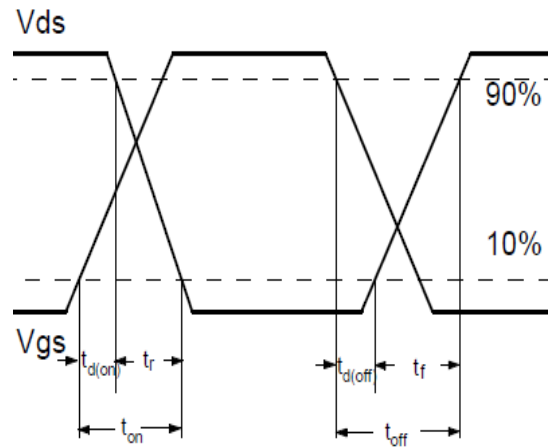

Fig.2-1 Gate charge test circuit

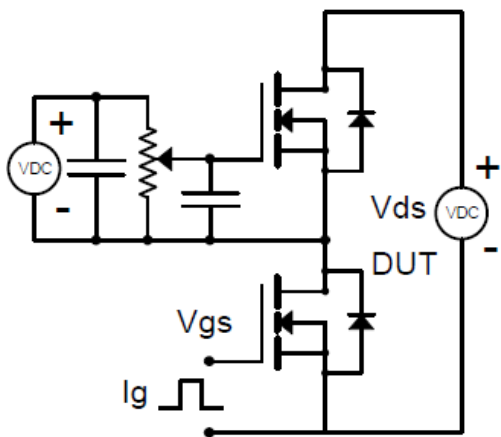

Fig.2-2 Gate charge waveform

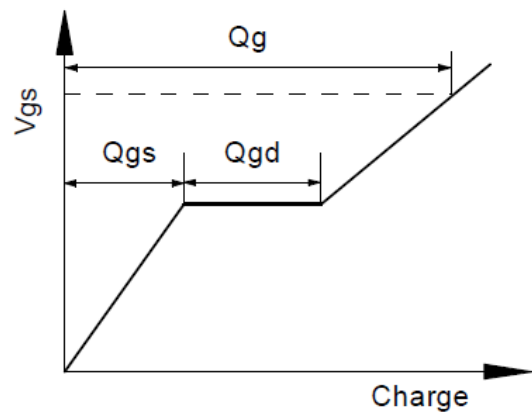

Fig.3-1 Avalanche test circuit

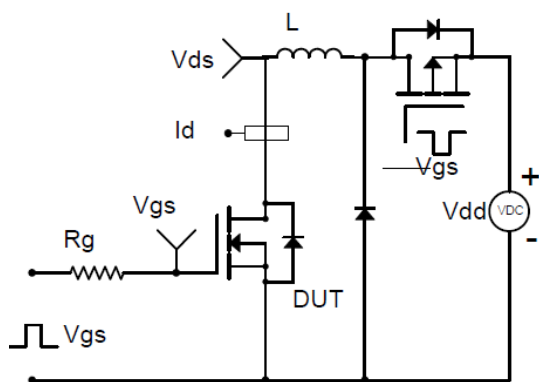
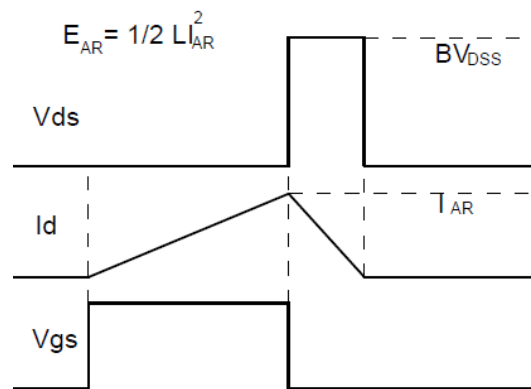

Fig.3-2 Avalanche waveform



# WTR04N065L-HAF

## Package Outline (Dimensions in mm)

TO-252

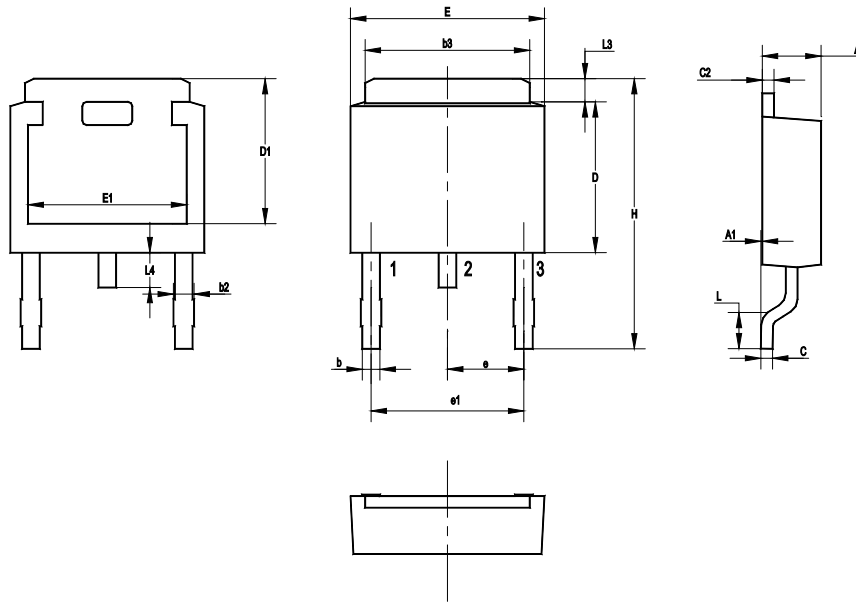

UNIT	A	A1	b	b2	b3	C	C2	D	D1	E	E1	e	e1	H	L	L3	L4
mm	2.5	0.15	1.0	1.15	5.5	0.65	0.65	6.2	5.4	6.7	5.0	2.30	4.60	10.7	1.78	1.20	1.10
	2.1	0	0.5	0.65	4.9	0.4	0.4	5.6	5.0	6.1	4.6	TYP.	TYP.	9	1.40	0.85	0.51

## Recommended Soldering Footprint

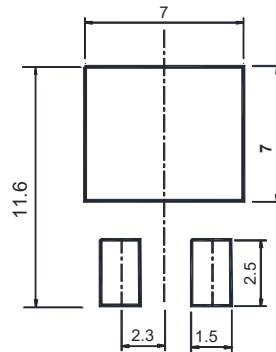

## Packing information

Package	Tape Width (mm)	Pitch		Reel Size		Per Reel Packing Quantity
		mm	inch	mm	inch	
TO-252	16	8 ± 0.1	0.315 ± 0.004	330	13	2,500

## Marking information

" TR04N065L " = Part No.

" \*\*\*\*\* " = Date Code Marking

Font type: Arial



Disclaimer: Our company reserve the right to make modifications, enhancements, improvements, corrections or other changes to improve product design, functions and reliability, anytime without notice.

