

WTQ10P1K4LS-HAF

P-Channel Enhancement Mode MOSFET

Features

- Surface-mounted package
- Halogen and Antimony Free(HAF),
RoHS compliant

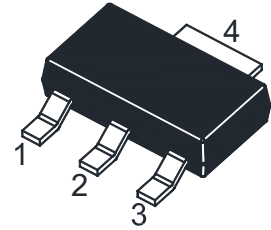
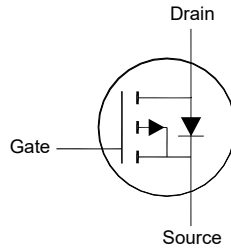

1.Gate 2.Drain 3.Source 4.Drain
SOT-223 Plastic Package

Key Parameters

Parameter	Value	Unit
BV_{DSS}	100	V
$R_{DS(ON)}$ Max	145 @ $V_{GS} = 10$ V	m Ω
	175 @ $V_{GS} = 4.5$ V	
$V_{GS(th)}$ typ	1.6	V
Q_g typ	35 @ $V_{GS} = 10$ V	nC

Absolute Maximum Ratings (at $T_a = 25^\circ\text{C}$ unless otherwise specified)

Parameter	Symbol	Value	Unit
Drain-Source Voltage	$-V_{DS}$	100	V
Gate-Source Voltage	V_{GS}	± 20	V
Drain Current	$-I_D$	$T_c = 25^\circ\text{C}$	10
		$T_c = 100^\circ\text{C}$	6
Peak Drain Current, Pulsed ¹⁾	$-I_{DM}$	35	A
Single-Pulse Avalanche Current	$-I_{AS}$	12.6	A
Single-Pulse Avalanche Energy ²⁾	E_{AS}	39.6	mJ
Power Dissipation	P_D	24.2	W
Operating Junction and Storage Temperature Range	T_J, T_{stg}	- 55 to + 150	$^\circ\text{C}$

Thermal Characteristics

Parameter	Symbol	Max.	Unit
Thermal Resistance from Junction to Case	$R_{\theta JC}$	5.1	$^\circ\text{C/W}$
Thermal Resistance from Junction to Ambient ³⁾	$R_{\theta JA}$	50	$^\circ\text{C/W}$

¹⁾ Pulse Test: Pulse Width ≤ 100 μs , Duty Cycle $\leq 2\%$, Repetitive rating, pulse width limited by junction temperature $T_{J(MAX)} = 150^\circ\text{C}$.

²⁾ Limited by $T_{J(MAX)}$, starting $T_J = 25^\circ\text{C}$, $L = 0.5$ mH, $R_g = 25$ Ω , $-I_{AS} = 12.6$ A, $-V_{GS} = 10$ V.

³⁾ Device mounted on FR-4 substrate PC board, 2oz copper, with 1-inch square copper plate in still air.

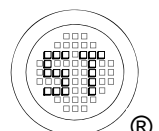

WTQ10P1K4LS-HAF

Characteristics at $T_a = 25^\circ\text{C}$ unless otherwise specified

Parameter	Symbol	Min.	Typ.	Max.	Unit
STATIC PARAMETERS					
Drain-Source Breakdown Voltage at $-I_D = 250 \mu\text{A}$	$-BV_{DSS}$	100	-	-	V
Drain-Source Leakage Current at $-V_{DS} = 100 \text{ V}$	$-I_{DSS}$	-	-	1	μA
Gate Leakage Current at $V_{GS} = \pm 20 \text{ V}$	I_{GSS}	-	-	± 100	nA
Gate-Source Threshold Voltage at $V_{DS} = V_{GS}$, $-I_D = 250 \mu\text{A}$	$-V_{GS(th)}$	1.2	-	2.5	V
Drain-Source On-State Resistance at $-V_{GS} = 10 \text{ V}$, $-I_D = 6 \text{ A}$ at $-V_{GS} = 4.5 \text{ V}$, $-I_D = 5 \text{ A}$	$R_{DS(on)}$	- -	110 -	145 175	m Ω
DYNAMIC PARAMETERS					
Forward Transconductance at $-V_{DS} = 5 \text{ V}$, $-I_D = 5 \text{ A}$	g_{FS}	-	13.5	-	S
Gate Resistance at $V_{GS} = 0 \text{ V}$, $V_{DS} = 0 \text{ V}$, $f = 1 \text{ MHz}$	R_g	-	5.7	-	Ω
Input Capacitance at $-V_{DS} = 50 \text{ V}$, $V_{GS} = 0 \text{ V}$, $f = 1 \text{ MHz}$	C_{iss}	-	2087	-	pF
Output Capacitance at $-V_{DS} = 50 \text{ V}$, $V_{GS} = 0 \text{ V}$, $f = 1 \text{ MHz}$	C_{oss}	-	55	-	pF
Reverse Transfer Capacitance at $-V_{DS} = 50 \text{ V}$, $V_{GS} = 0 \text{ V}$, $f = 1 \text{ MHz}$	C_{rss}	-	8	-	pF
Total Gate Charge at $-V_{GS} = 10 \text{ V}$, $-V_{DS} = 50 \text{ V}$, $-I_D = 6 \text{ A}$ at $-V_{GS} = 4.5 \text{ V}$, $-V_{DS} = 50 \text{ V}$, $-I_D = 6 \text{ A}$	Q_g	- -	35 16	- -	nC
Gate-Source Charge at $-V_{GS} = 10 \text{ V}$, $-V_{DS} = 50 \text{ V}$, $-I_D = 6 \text{ A}$	Q_{gs}	-	6	-	nC
Gate-Drain Charge at $-V_{GS} = 10 \text{ V}$, $-V_{DS} = 50 \text{ V}$, $-I_D = 6 \text{ A}$	Q_{gd}	-	5	-	nC
Turn-On Delay Time at $-V_{GS} = 10 \text{ V}$, $-V_{DS} = 50 \text{ V}$, $-I_D = 6 \text{ A}$, $R_G = 3.3 \Omega$	$t_{d(on)}$	-	12	-	ns
Turn-On Rise Time at $-V_{GS} = 10 \text{ V}$, $-V_{DS} = 50 \text{ V}$, $-I_D = 6 \text{ A}$, $R_G = 3.3 \Omega$	t_r	-	8	-	ns
Turn-Off Delay Time at $-V_{GS} = 10 \text{ V}$, $-V_{DS} = 50 \text{ V}$, $-I_D = 6 \text{ A}$, $R_G = 3.3 \Omega$	$t_{d(off)}$	-	25	-	ns
Turn-Off Fall Time at $-V_{GS} = 10 \text{ V}$, $-V_{DS} = 50 \text{ V}$, $-I_D = 6 \text{ A}$, $R_G = 3.3 \Omega$	t_f	-	5	-	ns
Body-Diode PARAMETERS					
Drain-Source Diode Forward Voltage at $-I_S = 1 \text{ A}$, $-V_{GS} = 0 \text{ V}$	$-V_{SD}$	-	-	1.2	V
Body-Diode Continuous Current	$-I_S$	-	-	10	A
Body-Diode Continuous Current, Pulsed	$-I_{SM}$	-	-	35	A
Body Diode Reverse Recovery Time at $-I_S = 6 \text{ A}$, $di/dt = 100 \text{ A} / \mu\text{s}$	t_{rr}	-	24.8	-	ns
Body Diode Reverse Recovery Charge at $-I_S = 6 \text{ A}$, $di/dt = 100 \text{ A} / \mu\text{s}$	Q_{rr}	-	30.8	-	nC

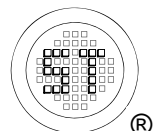

WTQ10P1K4LS-HAF

Electrical Characteristics Curves

Fig. 1 Typical Output Characteristics

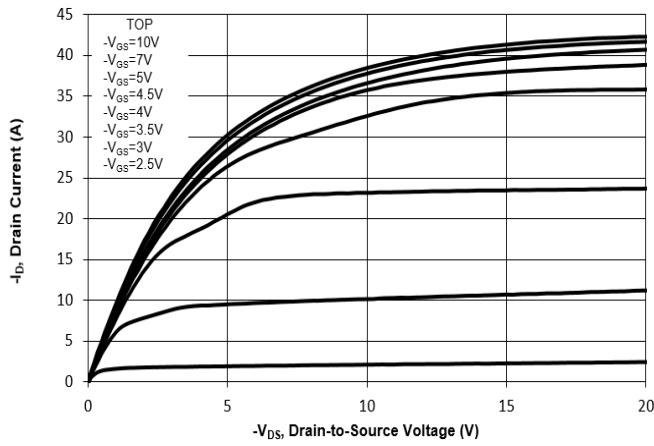

Fig. 2 Typical Transfer Characteristics

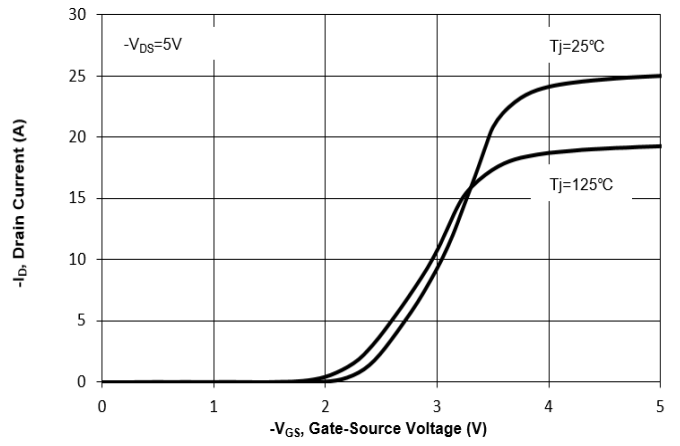

Fig. 3 On-Resistance vs. Drain Current

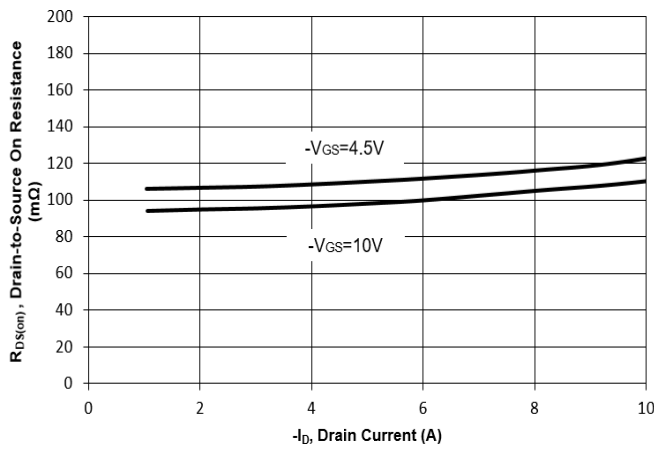

Fig. 4 On-Resistance vs. Gate Voltage

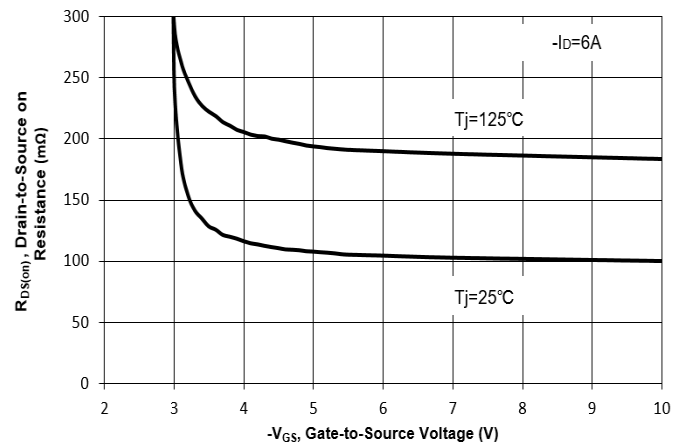

Fig. 5 On-Resistance vs. T_J

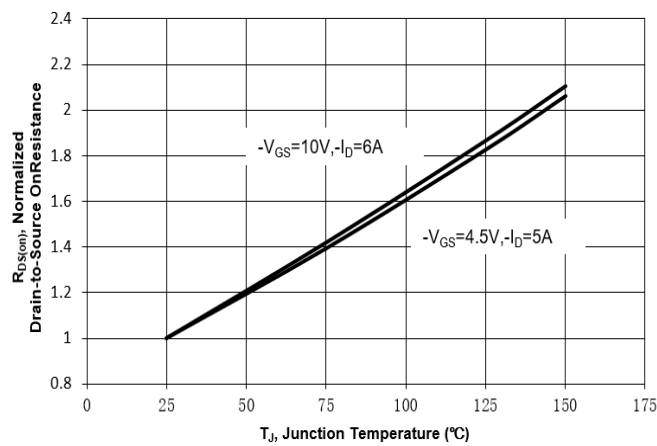
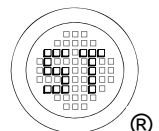
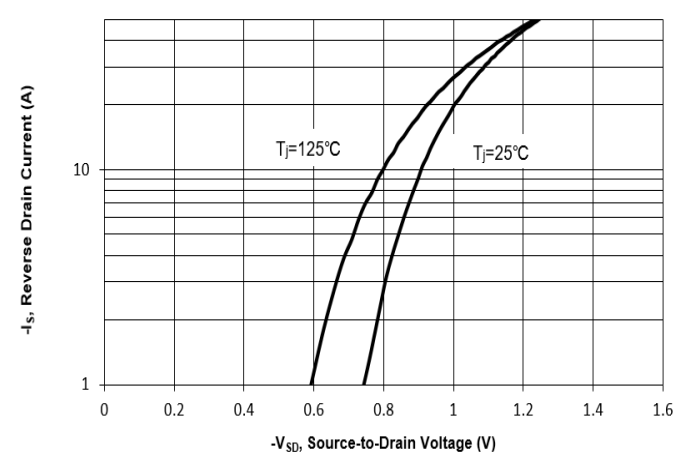

Fig. 6 Typical Body-Diode Forward Characteristics



WTQ10P1K4LS-HAF

Electrical Characteristics Curves

Fig. 7 Typical Junction Capacitance

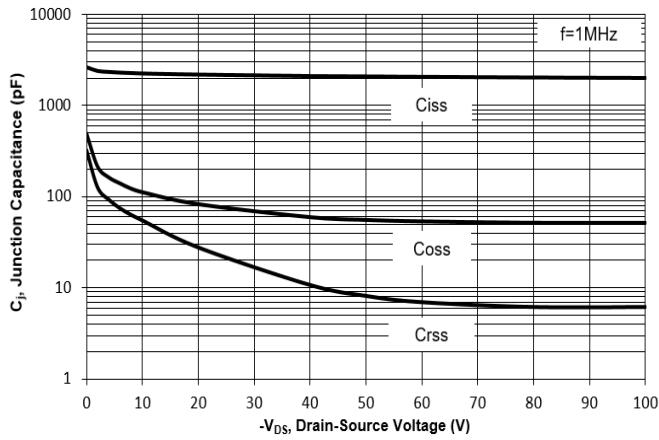

Fig. 8 Drain-Source Leakage Current vs. Tj

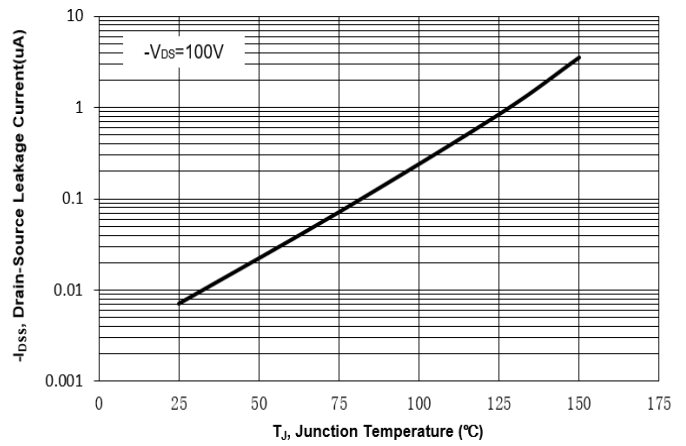

Fig. 9 $V_{(BR)DSS}$ vs. Junction Temperature

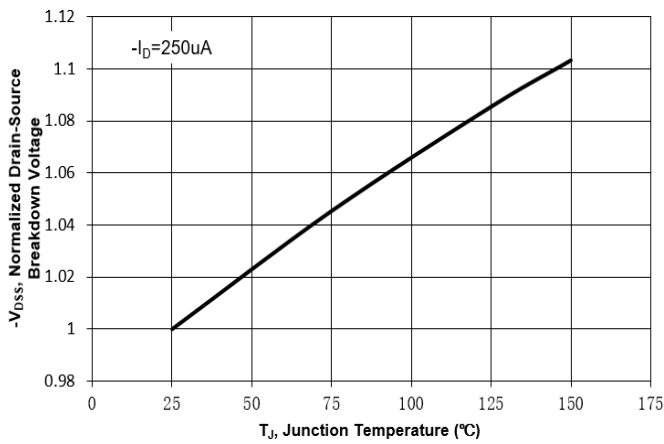

Fig. 10 Gate Threshold Variation vs. Tj

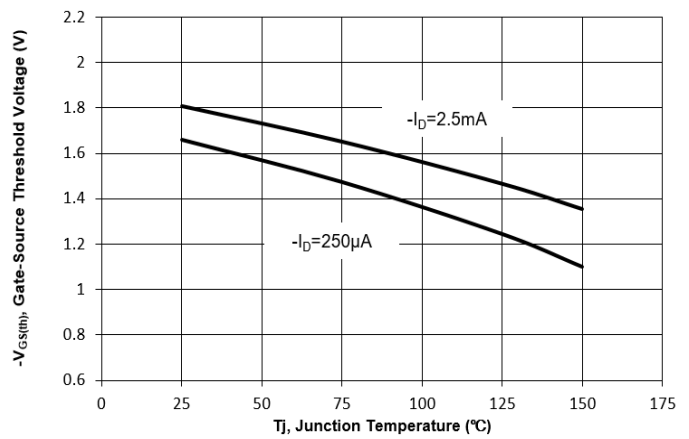

Fig. 11 Gate Charge

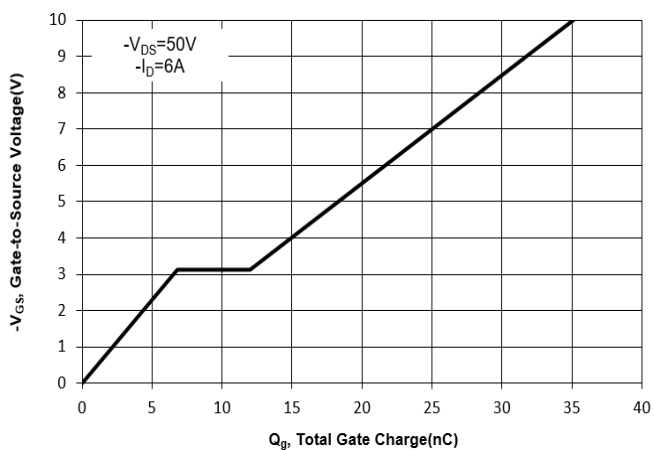
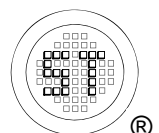
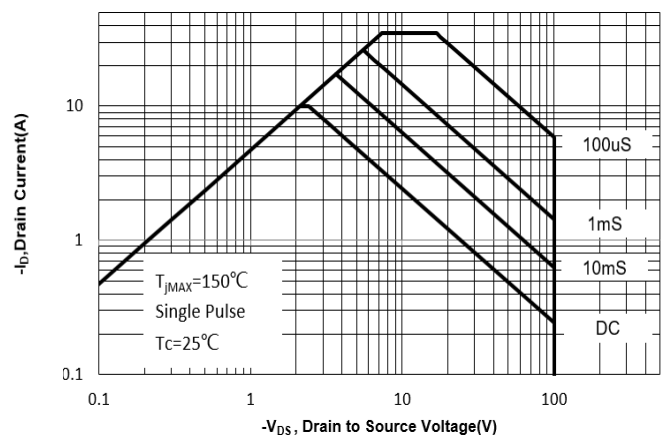

Fig. 12 Safe Operation Area



WTQ10P1K4LS-HAF

Electrical Characteristics Curves

Fig. 13 Normalized Maximum Transient Thermal Impedance($Z_{\theta JC}$)

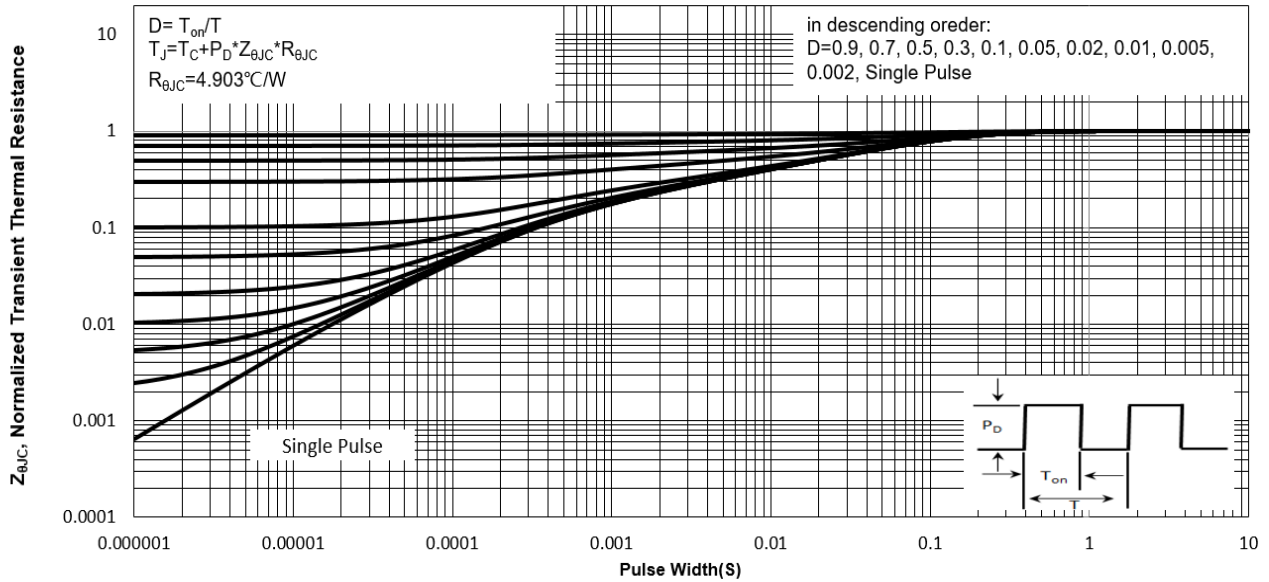
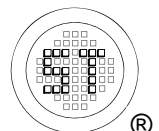
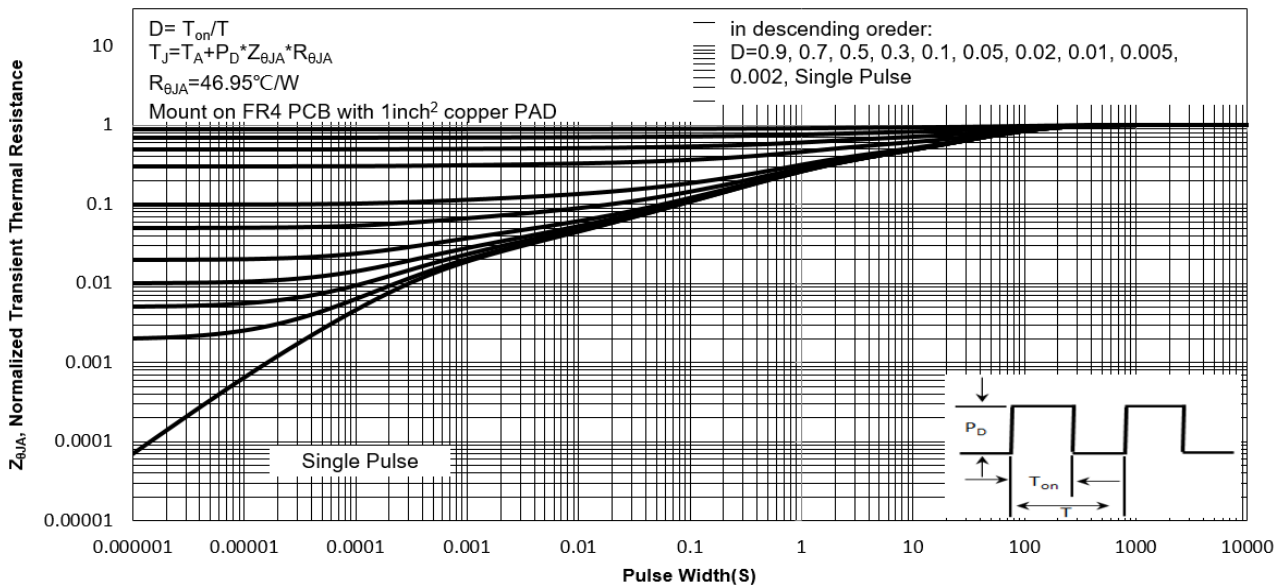

Fig. 14 Normalized Maximum Transient Thermal Impedance($Z_{\theta JA}$)



WTQ10P1K4LS-HAF

Test Circuits

Fig.1-1 Switching times test circuit

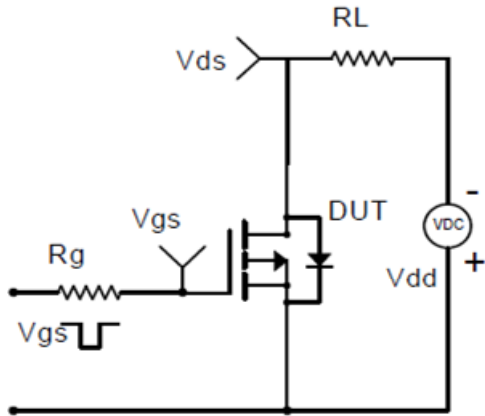

Fig.1-2 Switching Waveform

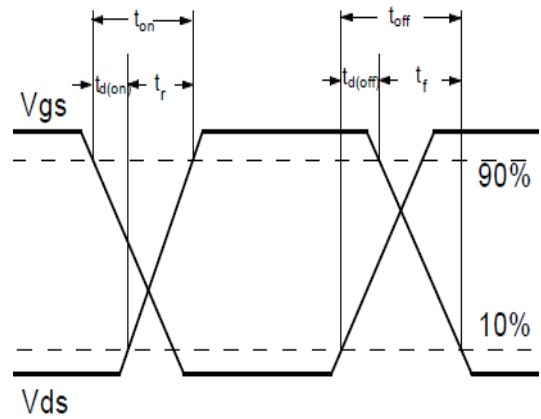

Fig.2-1 Gate charge test circuit

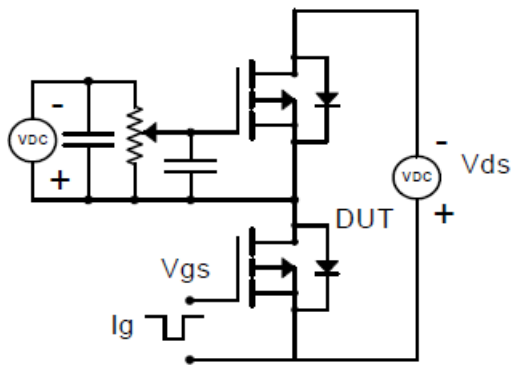

Fig.2-2 Gate charge waveform

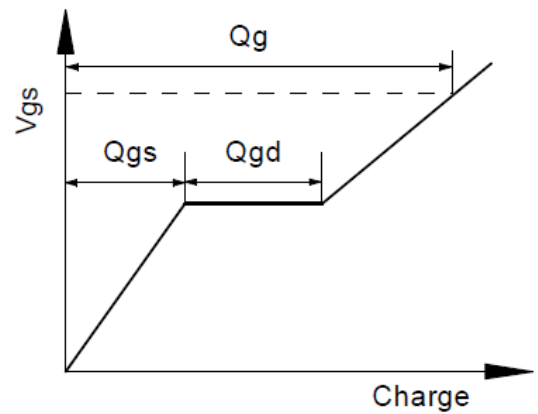

Fig.3-1 Avalanche test circuit

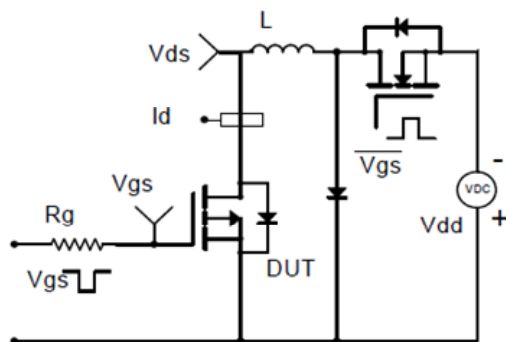
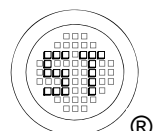
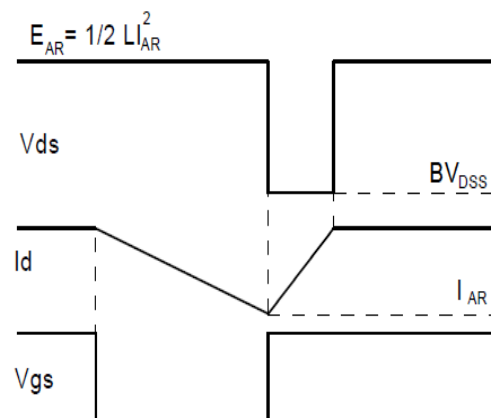

Fig.3-2 Avalanche waveform



WTQ10P1K4LS-HAF

Package Outline (Dimensions in mm)

SOT-223

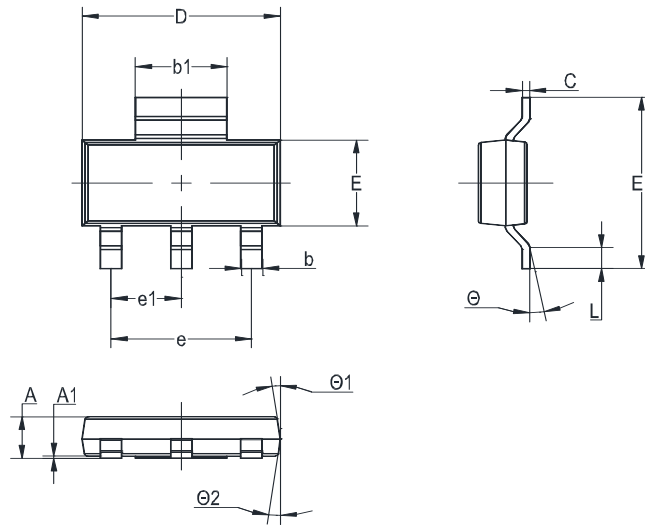

Unit	A	A1	b	b1	C	D	E	E1	e	e1	L	Θ	Θ1	Θ2
mm	1.8	0.1	0.8	3.1	0.32	6.7	3.7	7.3	4.6	2.3	1.1	10°	7°	7°
	1.5	MAX	0.6	2.9	0.22	6.3	3.3	6.7	TYP	TYP	0.7	0°	0°	0°

Recommended Soldering Footprint

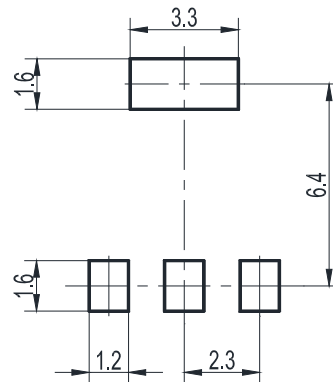

Packing information

Package	Tape Width (mm)	Pitch		Reel Size		Per Reel Packing Quantity
		mm	inch	mm	inch	
SOT-223	12	8 ± 0.1	0.315 ± 0.004	330	13	3,000

Marking information

" TQ10P1K4LS " = Part No.

" ***** " = Date Code Marking

Font type: Arial

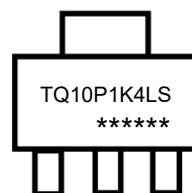

Disclaimer: Our company reserve the right to make modifications, enhancements, improvements, corrections or other changes to improve product design, functions and reliability, anytime without notice.

