

WDR04N110LS-HAF

N-Channel Enhancement Mode MOSFET

Features

- Surface-mounted package
- Halogen and Antimony Free(HAF)
RoHS compliant

Applications

- Load switch
- PWM applications
- LCD TV CCFL inverter

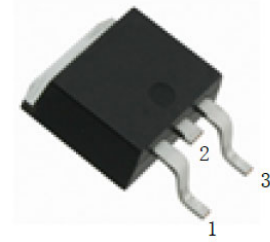
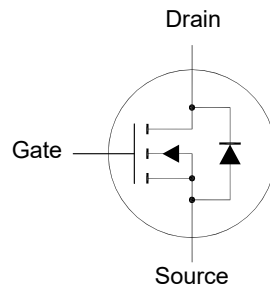

1.Gate 2.Drain 3.Source
TO-252 Plastic Package

Key Parameters

Parameter	Value	Unit
BV_{DSS}	40	V
$R_{DS(ON)}$ Max	11 @ $V_{GS} = 10$ V	m Ω
	16 @ $V_{GS} = 4.5$ V	
$V_{GS(th)}$ typ	1.7	V
Q_g typ	14 @ $V_{GS} = 10$ V	nC

Absolute Maximum Ratings (at $T_a = 25^\circ\text{C}$ unless otherwise specified)

Parameter	Symbol	Value	Unit
Drain-Source Voltage	V_{DS}	40	V
Gate-Source Voltage	V_{GS}	± 20	V
Drain Current	I_D	$T_c = 25^\circ\text{C}$	48
		$T_c = 100^\circ\text{C}$	30
Peak Drain Current Pulsed ¹⁾	I_{DM}	160	A
Avalanche Current	I_{AS}	12	A
Single Pulse Avalanche Energy ²⁾	E_{AS}	36	mJ
Power Dissipation	P_D	41.7	W
Operating Junction and Storage Temperature Range	T_j, T_{stg}	- 55 to + 150	$^\circ\text{C}$

Thermal Characteristics

Parameter	Symbol	Max.	Unit
Thermal Resistance from Junction to Case	$R_{\theta JC}$	3	$^\circ\text{C/W}$
Thermal Resistance from Junction to Ambient ³⁾	$R_{\theta JA}$	50	$^\circ\text{C/W}$

¹⁾ Pulse Test: Pulse Width ≤ 100 μs , Duty Cycle $\leq 2\%$, Repetitive rating, pulse width limited by junction temperature $T_{J(MAX)} = 150^\circ\text{C}$.

²⁾ Limited by $T_{J(MAX)}$, starting $T_j = 25^\circ\text{C}$, $L = 0.5$ mH, $R_g = 25$ Ω , $I_{AS} = 12$ A, $V_{GS} = 10$ V.

³⁾ Device mounted on FR-4 substrate PC board, 2oz copper, with 1-inch square copper plate in still air.

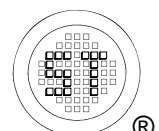

WDR04N110LS-HAF

Characteristics at $T_a = 25^\circ\text{C}$ unless otherwise specified

Parameter	Symbol	Min.	Typ.	Max.	Unit
STATIC PARAMETERS					
Drain-Source Breakdown Voltage at $I_D = 250 \mu\text{A}$	BV_{DSS}	40	-	-	V
Drain-Source Leakage Current at $V_{DS} = 40 \text{ V}$	I_{DSS}	-	-	1	μA
Gate-Source Leakage Current at $V_{GS} = \pm 20 \text{ V}$	I_{GSS}	-	-	± 100	nA
Gate-Source Threshold Voltage at $V_{DS} = V_{GS}$, $I_D = 250 \mu\text{A}$	$V_{GS(th)}$	1.2	-	2.5	V
Drain-Source On-State Resistance at $V_{GS} = 10 \text{ V}$, $I_D = 10 \text{ A}$ at $V_{GS} = 4.5 \text{ V}$, $I_D = 8 \text{ A}$	$R_{DS(on)}$	- -	8.5 -	11 16	$\text{m}\Omega$
DYNAMIC PARAMETERS					
Forward Transconductance at $V_{DS} = 5 \text{ V}$, $I_D = 5 \text{ A}$	g_{fs}	-	13	-	S
Gate resistance at $V_{GS} = 0 \text{ V}$, $V_{DS} = 0 \text{ V}$, $f = 1 \text{ MHz}$	R_g	-	2	-	Ω
Input Capacitance at $V_{GS} = 0 \text{ V}$, $V_{DS} = 30 \text{ V}$, $f = 1 \text{ MHz}$	C_{iss}	-	825	-	pF
Output Capacitance at $V_{GS} = 0 \text{ V}$, $V_{DS} = 30 \text{ V}$, $f = 1 \text{ MHz}$	C_{oss}	-	290	-	pF
Reverse Transfer Capacitance at $V_{GS} = 0 \text{ V}$, $V_{DS} = 30 \text{ V}$, $f = 1 \text{ MHz}$	C_{rss}	-	15	-	pF
Gate charge total at $V_{DS} = 30 \text{ V}$, $I_D = 10 \text{ A}$, $V_{GS} = 10 \text{ V}$ at $V_{DS} = 30 \text{ V}$, $I_D = 10 \text{ A}$, $V_{GS} = 4.5 \text{ V}$	Q_g	- -	14 7.2	- -	nC
Gate to Source Charge at $V_{DS} = 30 \text{ V}$, $I_D = 10 \text{ A}$, $V_{GS} = 10 \text{ V}$	Q_{gs}	-	2.6	-	nC
Gate to Drain Charge at $V_{DS} = 30 \text{ V}$, $I_D = 10 \text{ A}$, $V_{GS} = 10 \text{ V}$	Q_{gd}	-	2.8	-	nC
Turn-On Delay Time at $V_{DS} = 30 \text{ V}$, $I_D = 10 \text{ A}$, $V_{GS} = 10 \text{ V}$, $R_g = 4.7 \Omega$	$t_{d(on)}$	-	10	-	ns
Turn-On Rise Time at $V_{DS} = 30 \text{ V}$, $I_D = 10 \text{ A}$, $V_{GS} = 10 \text{ V}$, $R_g = 4.7 \Omega$	t_r	-	16	-	ns
Turn-Off Delay Time at $V_{DS} = 30 \text{ V}$, $I_D = 10 \text{ A}$, $V_{GS} = 10 \text{ V}$, $R_g = 4.7 \Omega$	$t_{d(off)}$	-	9	-	ns
Turn-Off Fall Time at $V_{DS} = 30 \text{ V}$, $I_D = 10 \text{ A}$, $V_{GS} = 10 \text{ V}$, $R_g = 4.7 \Omega$	t_f	-	2	-	ns
Body-Diode PARAMETERS					
Drain-Source Diode Forward Voltage at $I_S = 1 \text{ A}$, $V_{GS} = 0 \text{ V}$	V_{SD}	-	-	1.2	V
Body-Diode Continuous Current	I_S	-	-	48	A
Body-Diode Continuous Current, Pulsed	I_{SM}	-	-	160	A
Body Diode Reverse Recovery Time at $I_S = 10 \text{ A}$, $di/dt = 100 \text{ A} / \mu\text{s}$	t_{rr}	-	17	-	ns
Body Diode Reverse Recovery Charge at $I_S = 10 \text{ A}$, $di/dt = 100 \text{ A} / \mu\text{s}$	Q_{rr}	-	6.5	-	nc

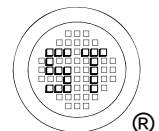

WDR04N110LS-HAF

Electrical Characteristics Curves

Fig. 1 Typical Output Characteristics

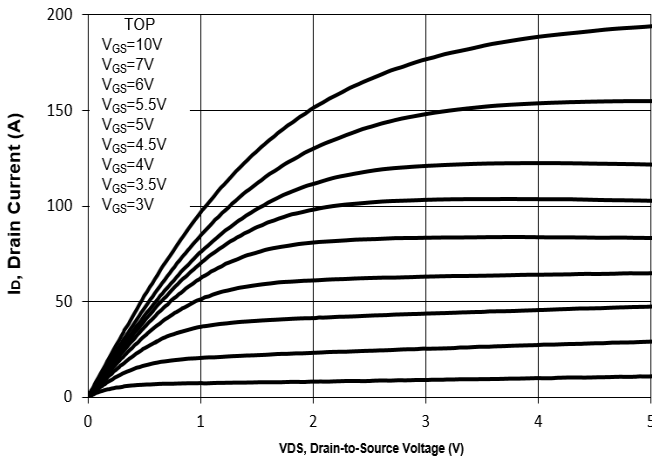

Fig. 2 Typical Transfer Characteristics

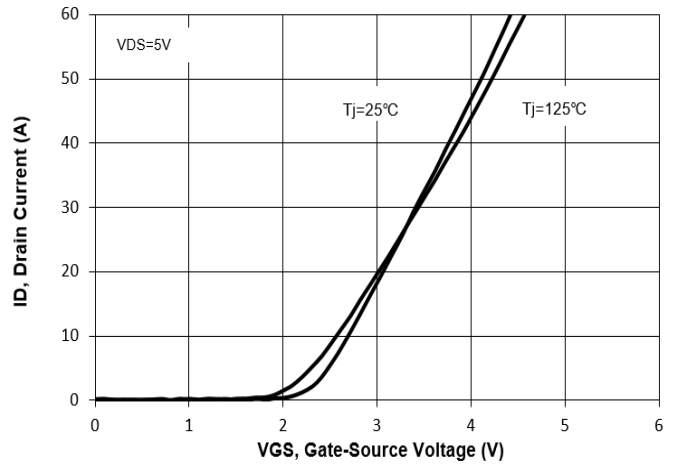

Fig. 3 on-Resistance vs. Drain Current

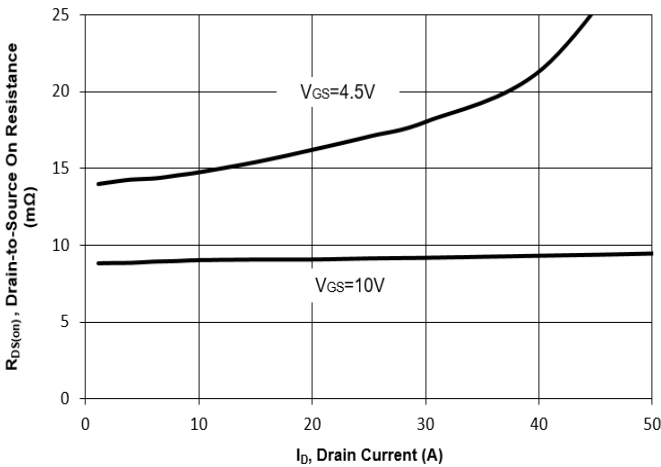

Fig. 4 on-Resistance vs. Gate Voltage

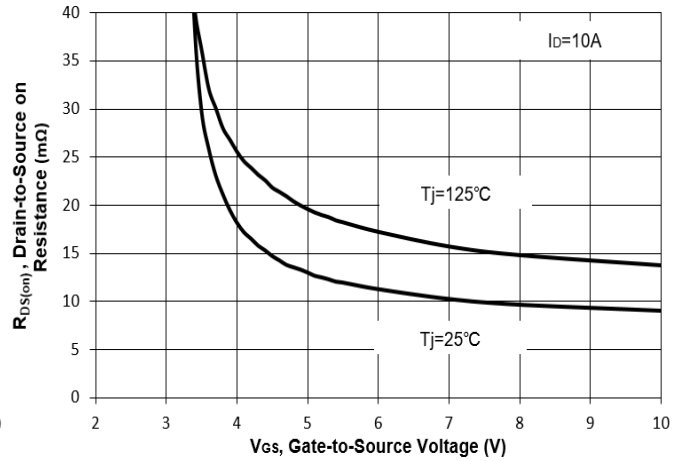

Fig. 5 on-Resistance vs. Tj

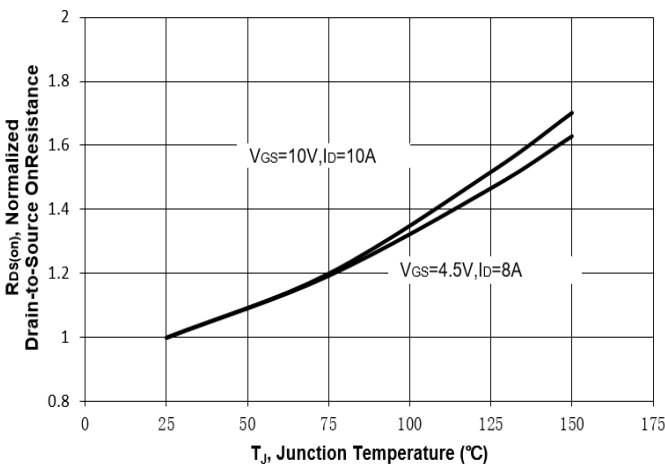
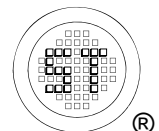
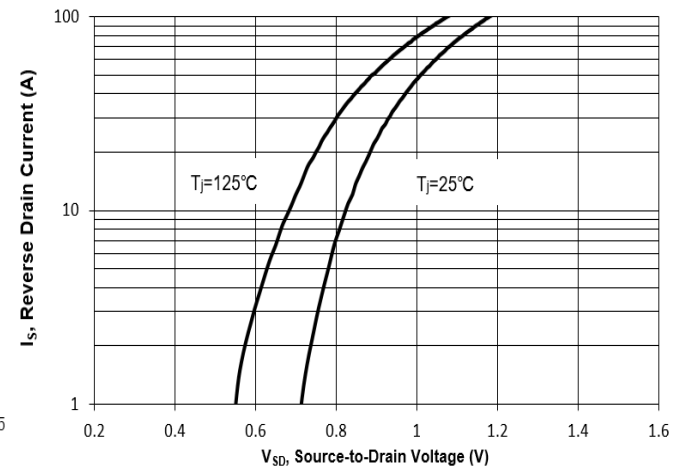

Fig. 6 Typical Body-Diode Forward Characteristics



WDR04N110LS-HAF

Electrical Characteristics Curves

Fig. 7 Typical Junction Capacitance

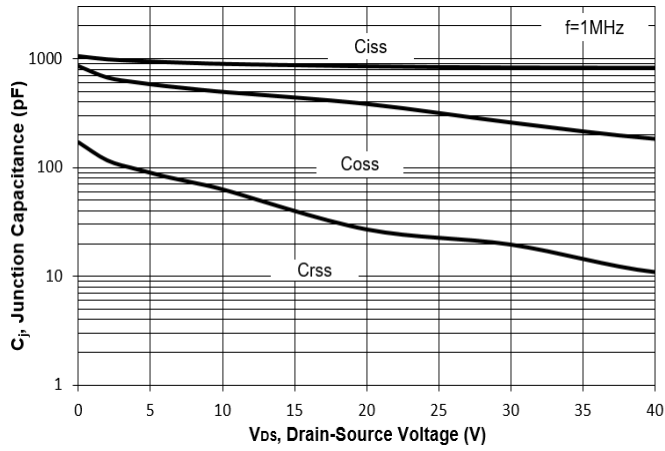

Fig. 8 Drain-Source Leakage Current vs. Tj

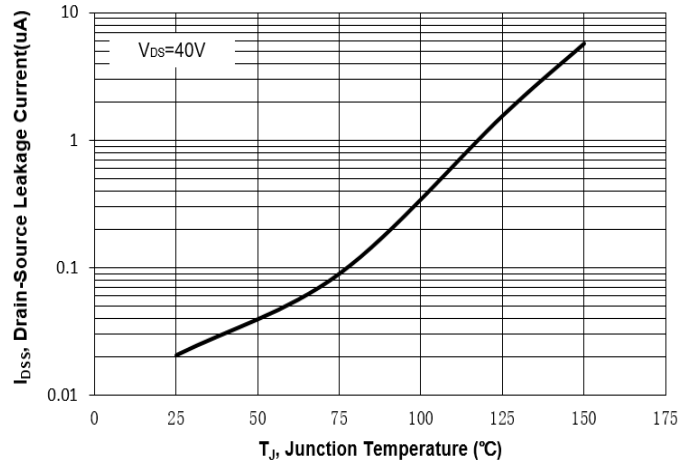

Fig. 9 V(BR)DSS vs. Junction Temperature

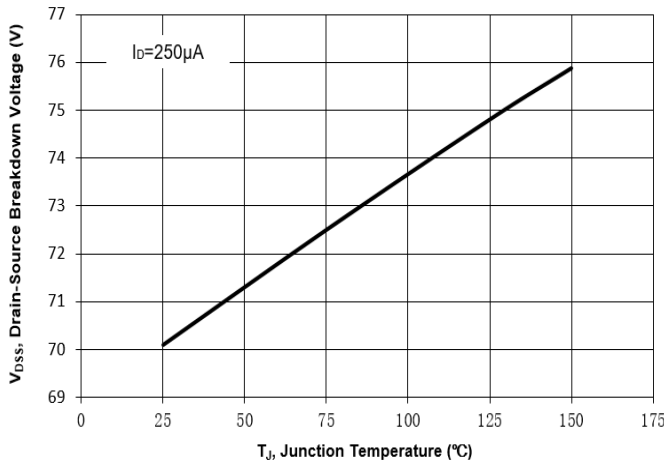

Fig. 10 Gate Threshold Variation vs. Tj

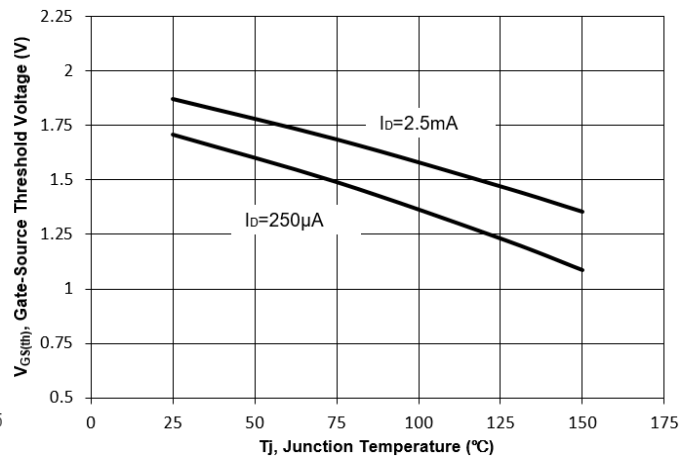

Fig. 11 Gate Charge

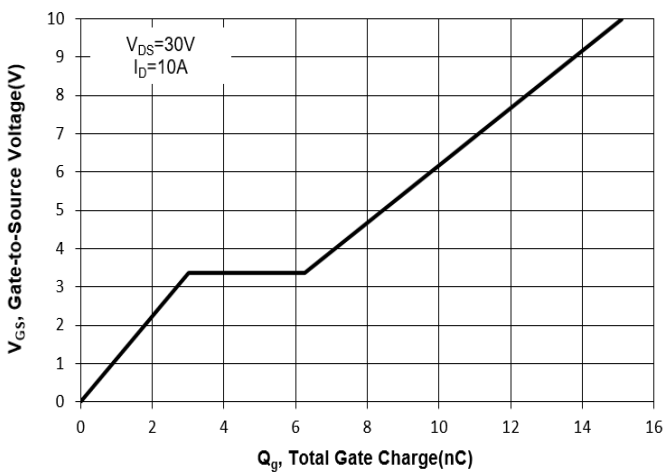
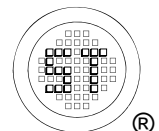
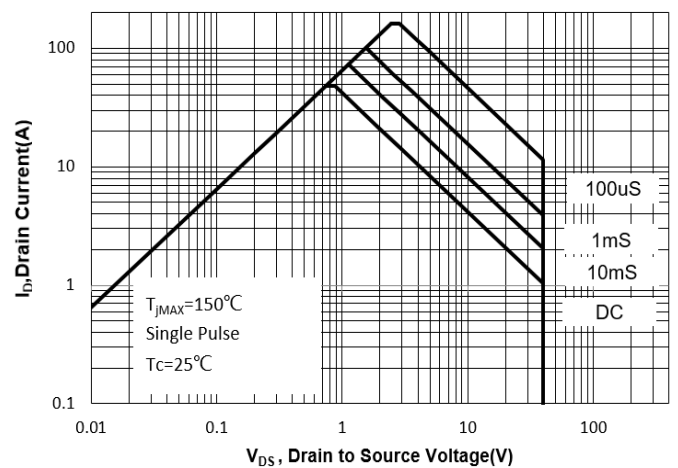

Fig. 12 Safe Operation Area



WDR04N110LS-HAF

Electrical Characteristics Curves

Fig. 13 Normalized Maximum Transient Thermal Impedance($Z_{\theta JC}$)

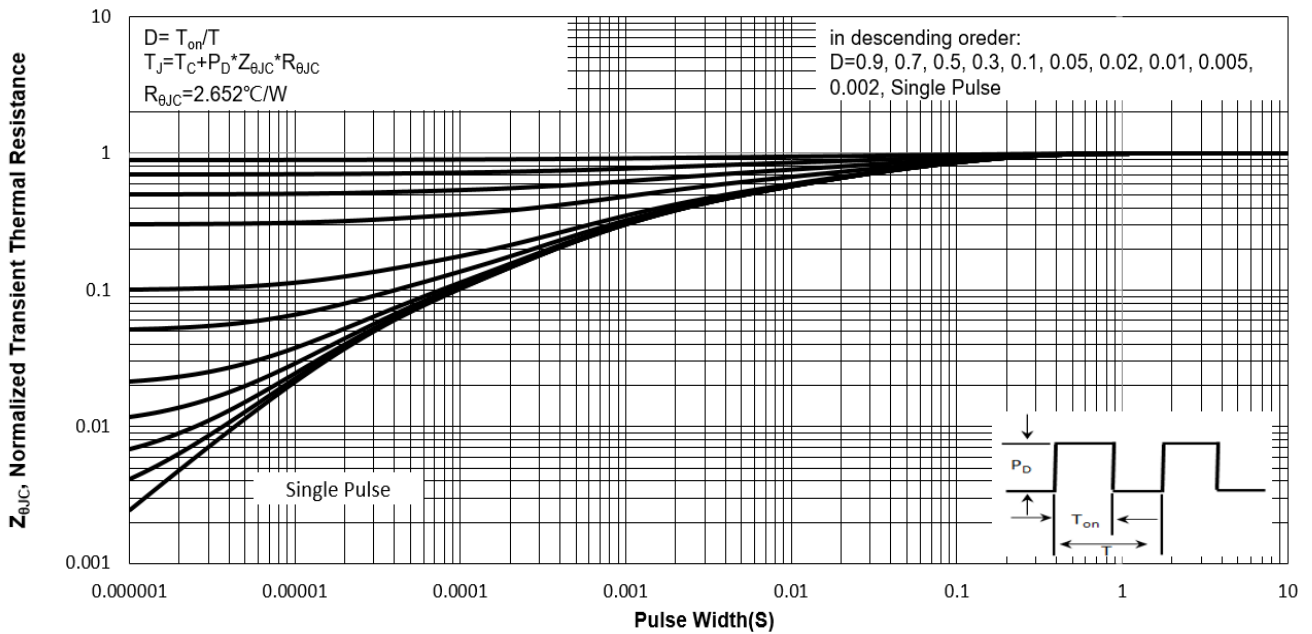
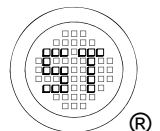
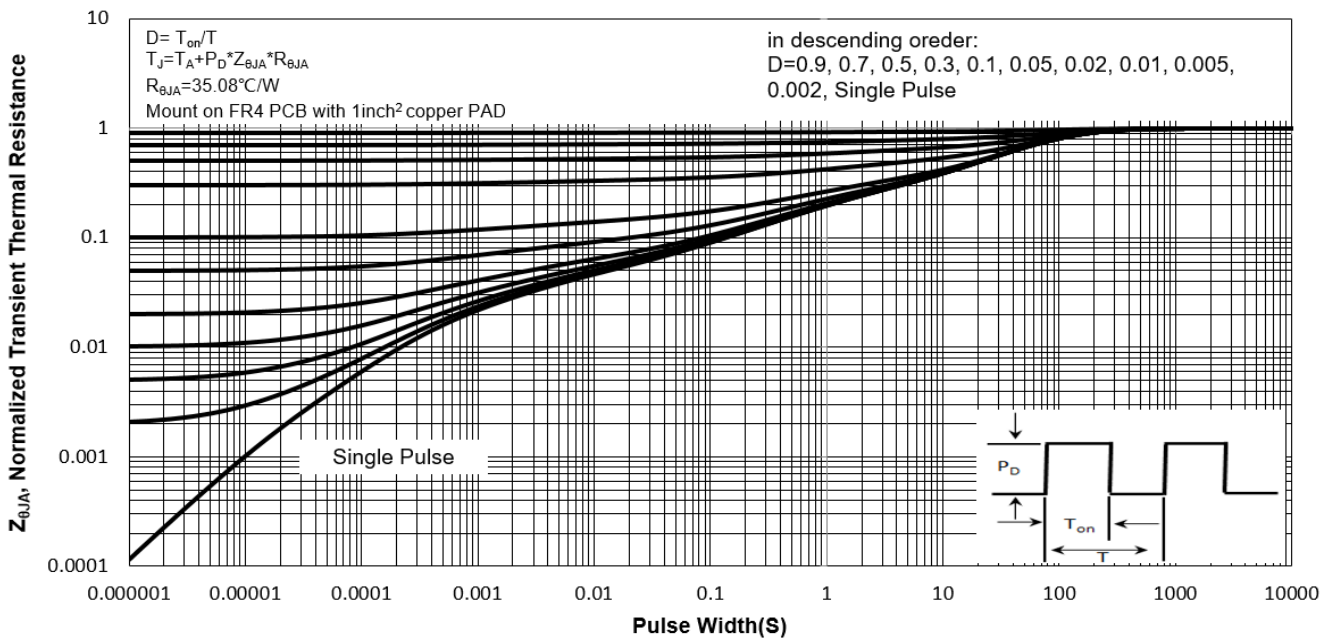

Fig. 14 Normalized Maximum Transient Thermal Impedance($Z_{\theta JA}$)



Test Circuits

Fig.1-1 Switching times test circuit

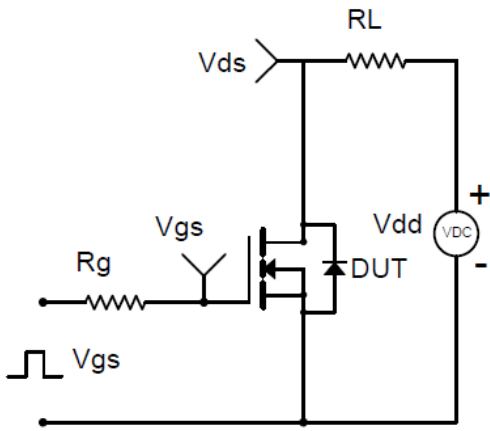

Fig.1-2 Switching Waveform

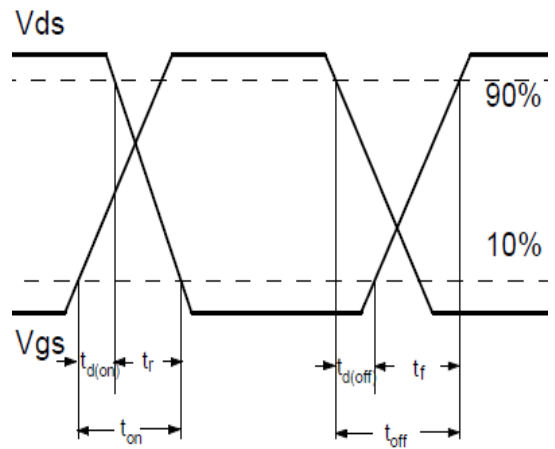

Fig.2-1 Gate charge test circuit

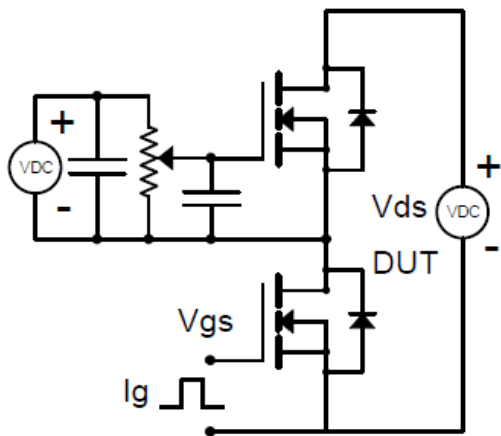

Fig.2-2 Gate charge waveform

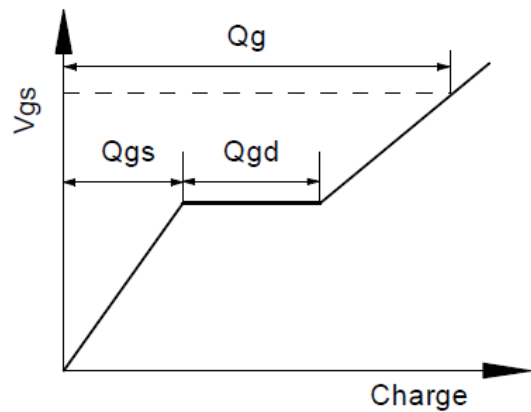

Fig.3-1 Avalanche test circuit

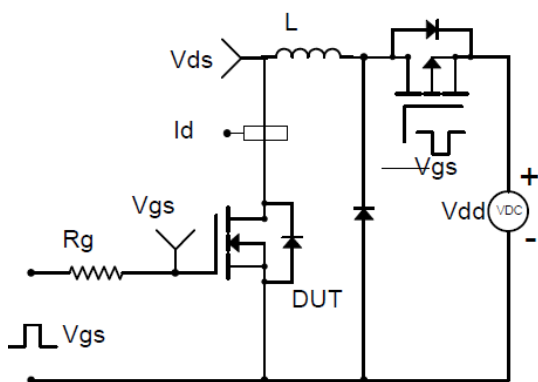
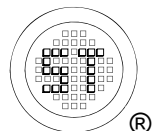
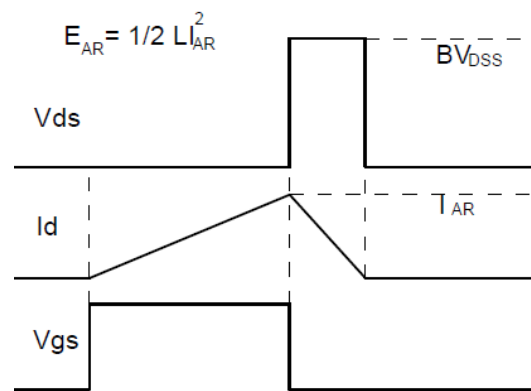

Fig.3-2 Avalanche waveform



WDR04N110LS-HAF

Package Outline (Dimensions in mm)

TO-252

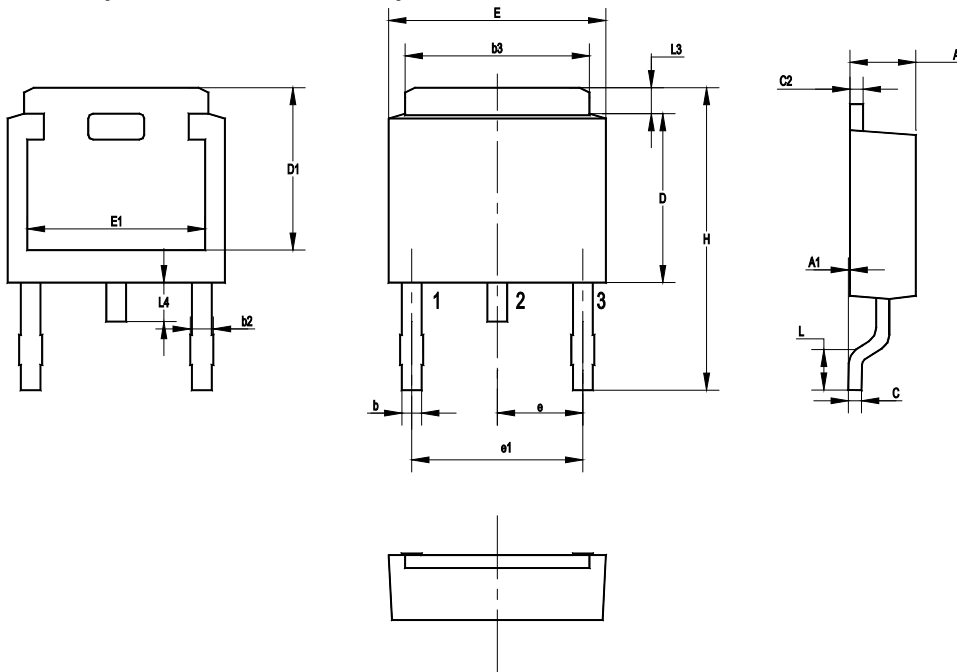

UNIT	A	A1	b	b2	b3	C	C2	D	D1	E	E1	e	e1	H	L	L3	L4
mm	2.5	0.15	1.0	1.15	5.5	0.65	0.65	6.2	5.4	6.7	5.0	2.30	4.60	10.7	1.78	1.20	1.10
	2.1	0	0.5	0.65	4.9	0.4	0.4	5.6	5.0	6.1	4.6	TYP.	TYP.	9	1.40	0.85	0.51

Recommended Soldering Footprint

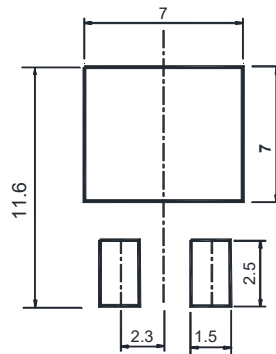

Packing information

Package	Tape Width (mm)	Pitch		Reel Size		Per Reel Packing Quantity
		mm	inch	mm	inch	
TO-252	16	8 ± 0.1	0.315 ± 0.004	330	13	2,500

Marking information

" DR04N110LS " = Part No.

" ***** " = Date Code Marking

Font type: Arial



Disclaimer: Our company reserve the right to make modifications, enhancements, improvements, corrections or other changes to improve product design, functions and reliability, anytime without notice.

