

MMFTX3008KDW-CH

Complementary N/P-Channel Enhancement Mode MOSFET

Features

- AEC-Q101 Qualified
- Low threshold voltage
- Built-in G-S Protection Diode
- Halogen and Antimony Free(HAF), RoHS compliant
- Typical ESD Protection HBM Class 1C

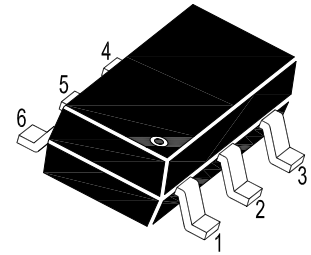
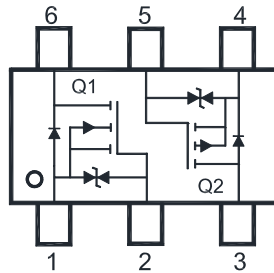

Q1: 1.Source 2.Gate 6.Drain
Q2: 4.Source 5.Gate 3.Drain
SOT-363 Plastic Package

Classification	Voltage Range(V)
0A	< 125
0B	125 to < 250
1A	250 to < 500
1B	500 to < 1000
1C	1000 to < 2000
2	2000 to < 4000
3A	4000 to < 8000
3B	≥ 8000

Application

- Portable appliances
- Battery management

Absolute Maximum Ratings (at $T_a = 25^\circ\text{C}$ unless otherwise specified) (Q1/Q2)

Parameter	Symbol	Value		Unit
		Q1	Q2	
Drain-Source Voltage	V_{DS}	30	-30	V
Gate-Source Voltage	V_{GS}	± 8	± 8	V
Continuous Drain Current	I_D	350	-200	mA
Peak Drain Current, Pulsed ¹⁾	I_{DM}	1.4	-0.8	A
Total Power Dissipation	P_{tot}	280 ²⁾ 320 ³⁾		mW
Operating Junction and Storage Temperature Range	T_J, T_{stg}	- 55 to + 150		°C

Thermal Characteristics (Q1/Q2)

Parameter	Symbol	Max.	Unit
Thermal Resistance from Junction to Ambient	$R_{\theta JA}$	446 ²⁾ 390 ³⁾	°C/W

¹⁾ Pulse Test: Pulse Width ≤ 100 μs, Duty Cycle ≤ 2%, Repetitive rating, pulse width limited by junction temperature $T_{J(MAX)}=150^\circ\text{C}$.

²⁾ Device mounted on FR-4 substrate PC board, 2oz copper, with minimum recommended pad.

³⁾ Device mounted on FR-4 substrate PC board, 2oz copper, with 1-inch square copper plate.

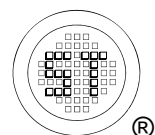

MMFTX3008KDW-CH

Characteristics at $T_a = 25^\circ\text{C}$ unless otherwise specified (N-Channel Q1)

Parameter	Symbol	Min.	Typ.	Max.	Unit
STATIC PARAMETERS					
Drain-Source Breakdown Voltage at $I_D = 250 \mu\text{A}$	BV_{DSS}	30	-	-	V
Drain-Source Leakage Current at $V_{DS} = 30 \text{ V}$	I_{DSS}	-	-	1	μA
Gate Leakage Current at $V_{GS} = \pm 8 \text{ V}$	I_{GSS}	-	-	± 1	μA
Gate-Source Threshold Voltage at $V_{DS} = V_{GS}$, $I_D = 250 \mu\text{A}$	$V_{GS(th)}$	0.5	-	1.1	V
Static Drain Source On-Resistance at $V_{GS} = 4.5 \text{ V}$, $I_D = 350 \text{ mA}$ at $V_{GS} = 2.5 \text{ V}$, $I_D = 200 \text{ mA}$ at $V_{GS} = 1.8 \text{ V}$, $I_D = 10 \text{ mA}$	$R_{DS(ON)}$	- - -	- - -	1.4 2.1 2.8	Ω
DYNAMIC PARAMETERS					
Forward Transconductance at $V_{DS} = 4.5 \text{ V}$, $I_D = 350 \text{ mA}$	g_{fs}	-	1.1	-	S
Input Capacitance at $V_{DS} = 15 \text{ V}$, $V_{GS} = 0 \text{ V}$, $f = 1 \text{ MHz}$	C_{iss}	-	54	-	pF
Output Capacitance at $V_{DS} = 15 \text{ V}$, $V_{GS} = 0 \text{ V}$, $f = 1 \text{ MHz}$	C_{oss}	-	9.4	-	pF
Reverse Transfer Capacitance at $V_{DS} = 15 \text{ V}$, $V_{GS} = 0 \text{ V}$, $f = 1 \text{ MHz}$	C_{rss}	-	4.4	-	pF
Gate charge total at $V_{DS} = 15 \text{ V}$, $I_D = 0.5 \text{ A}$, $V_{GS} = 4.5 \text{ V}$ at $V_{DS} = 15 \text{ V}$, $I_D = 0.5 \text{ A}$, $V_{GS} = 2.5 \text{ V}$	Q_g	- -	0.8 0.42	- -	nC
Gate to Source Charge at $V_{DS} = 15 \text{ V}$, $I_D = 0.5 \text{ A}$, $V_{GS} = 4.5 \text{ V}$	Q_{gs}	-	0.2	-	nC
Gate to Drain Charge at $V_{DS} = 15 \text{ V}$, $I_D = 0.5 \text{ A}$, $V_{GS} = 4.5 \text{ V}$	Q_{gd}	-	0.08	-	nC
Turn-On Delay Time at $V_{DS} = 15 \text{ V}$, $V_{GS} = 4.5 \text{ V}$, $I_D = 0.5 \text{ A}$, $R_G = 4.7 \Omega$	$t_{d(on)}$	-	1.8	-	ns
Turn-On Rise Time at $V_{DS} = 15 \text{ V}$, $V_{GS} = 4.5 \text{ V}$, $I_D = 0.5 \text{ A}$, $R_G = 4.7 \Omega$	t_r	-	18	-	ns
Turn-Off Delay Time at $V_{DS} = 15 \text{ V}$, $V_{GS} = 4.5 \text{ V}$, $I_D = 0.5 \text{ A}$, $R_G = 4.7 \Omega$	$t_{d(off)}$	-	29	-	ns
Turn-Off Fall Time at $V_{DS} = 15 \text{ V}$, $V_{GS} = 4.5 \text{ V}$, $I_D = 0.5 \text{ A}$, $R_G = 4.7 \Omega$	t_f	-	22	-	ns
Body-Diode PARAMETERS					
Drain-Source Diode Forward Voltage at $I_S = 350 \text{ mA}$	V_{SD}	-	-	1.2	V
Body-Diode Continuous Current	I_S	-	-	350	mA

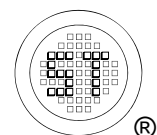

MMFTX3008KDW-CH

Characteristics at $T_a = 25^\circ\text{C}$ unless otherwise specified (P-Channel Q2)

Parameter	Symbol	Min.	Typ.	Max.	Unit
STATIC PARAMETERS					
Drain-Source Breakdown Voltage at $-I_D = 250 \mu\text{A}$	$-BV_{DSS}$	30	-	-	V
Drain-Source Leakage Current at $-V_{DS} = 30 \text{ V}$	$-I_{DSS}$	-	-	1	μA
Gate Leakage Current at $V_{GS} = \pm 8 \text{ V}$	I_{GSS}	-	-	± 1	μA
Gate-Source Threshold Voltage at $V_{DS} = V_{GS}$, $-I_D = 250 \mu\text{A}$	$-V_{GS(th)}$	0.5	-	1.1	V
Drain-Source On-State Resistance at $-V_{GS} = 4.5 \text{ V}$, $-I_D = 200 \text{ mA}$ at $-V_{GS} = 2.5 \text{ V}$, $-I_D = 10 \text{ mA}$	$R_{DS(on)}$	- -	- -	4.1 6.5	Ω
DYNAMIC PARAMETERS					
Forward Transconductance at $-V_{DS} = 4.5 \text{ V}$, $-I_D = 200 \text{ mA}$	g_{fs}	-	510	-	mS
Input Capacitance at $-V_{DS} = 10 \text{ V}$, $V_{GS} = 0 \text{ V}$, $f = 1 \text{ MHz}$	C_{iss}	-	50	-	pF
Output Capacitance at $-V_{DS} = 10 \text{ V}$, $V_{GS} = 0 \text{ V}$, $f = 1 \text{ MHz}$	C_{oss}	-	6	-	pF
Reverse Transfer Capacitance at $-V_{DS} = 10 \text{ V}$, $V_{GS} = 0 \text{ V}$, $f = 1 \text{ MHz}$	C_{rss}	-	5	-	pF
Total Gate Charge at $-V_{DS} = 10 \text{ V}$, $-V_{GS} = 4.5 \text{ V}$, $-I_D = 0.1 \text{ A}$ at $-V_{DS} = 10 \text{ V}$, $-V_{GS} = 2.5 \text{ V}$, $-I_D = 0.1 \text{ A}$	Q_g	- -	1.22 0.8	- -	nC
Gate to Source Charge at $-V_{DS} = 10 \text{ V}$, $-V_{GS} = 4.5 \text{ V}$, $-I_D = 0.1 \text{ A}$	Q_{gs}	-	0.33	-	nC
Gate to Drain Charge at $-V_{DS} = 10 \text{ V}$, $-V_{GS} = 4.5 \text{ V}$, $-I_D = 0.1 \text{ A}$	Q_{gd}	-	0.22	-	nC
Turn-On Delay Time at $-V_{DD} = 10 \text{ V}$, $-V_{GS} = 4.5 \text{ V}$, $-I_D = 0.1 \text{ A}$, $R_G = 4.7 \Omega$	$t_{d(on)}$	-	3.4	-	ns
Turn-On Rise Time at $-V_{DD} = 10 \text{ V}$, $-V_{GS} = 4.5 \text{ V}$, $-I_D = 0.1 \text{ A}$, $R_G = 4.7 \Omega$	t_r	-	13	-	ns
Turn-Off Delay Time at $-V_{DD} = 10 \text{ V}$, $-V_{GS} = 4.5 \text{ V}$, $-I_D = 0.1 \text{ A}$, $R_G = 4.7 \Omega$	$t_{d(off)}$	-	37	-	ns
Turn-Off Fall Time at $-V_{DD} = 10 \text{ V}$, $-V_{GS} = 4.5 \text{ V}$, $-I_D = 0.1 \text{ A}$, $R_G = 4.7 \Omega$	t_f	-	23	-	ns
Body-Diode PARAMETERS					
Drain-Source Diode Forward Voltage at $-I_S = 200 \text{ mA}$	$-V_{SD}$	-	-	1.2	V
Body-Diode Continuous Current	$-I_S$	-	-	200	mA

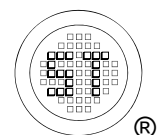

MMFTX3008KDW-CH

Electrical characteristics curves (N-Channel Q1)

Fig. 1 Typical Output Characteristics

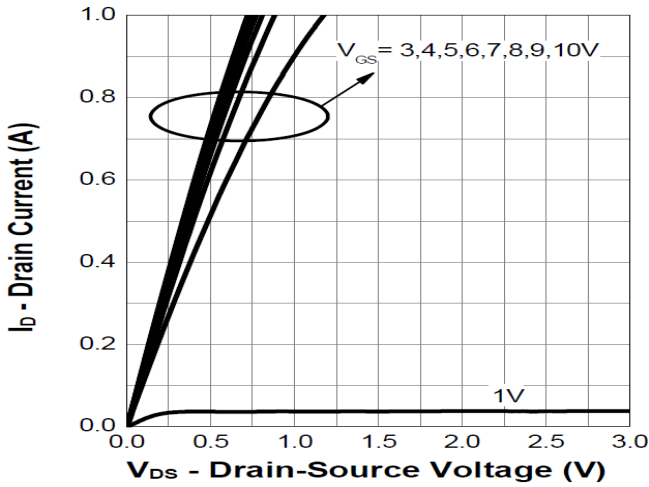

Fig. 2 Gate Threshold Variation vs. T_j

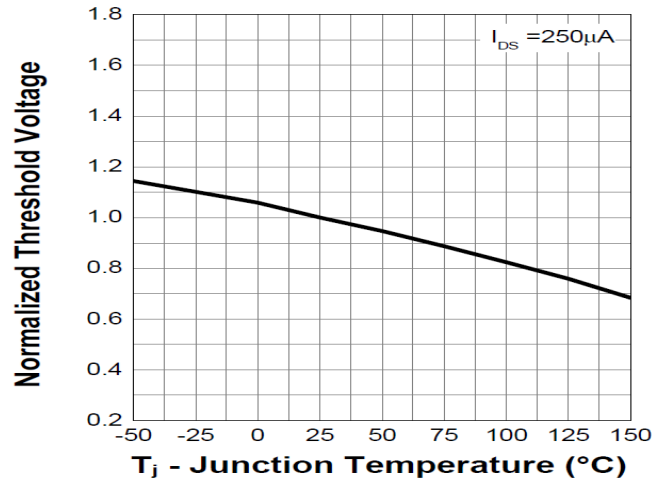

Fig. 3 on-Resistance vs. Drain Current

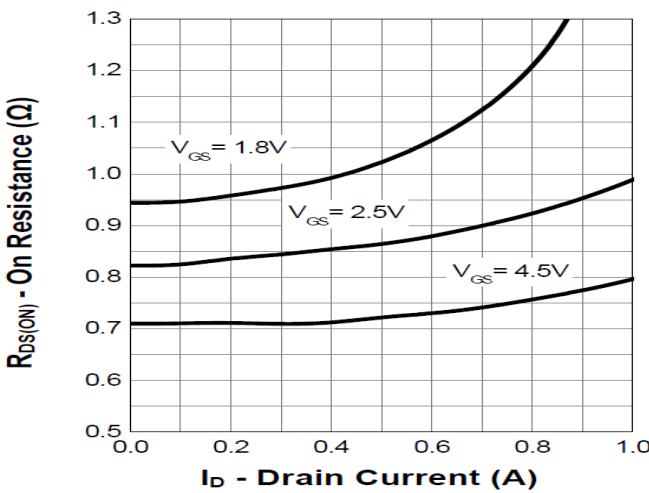

Fig. 4 on-Resistance vs. Gate-Source Voltage

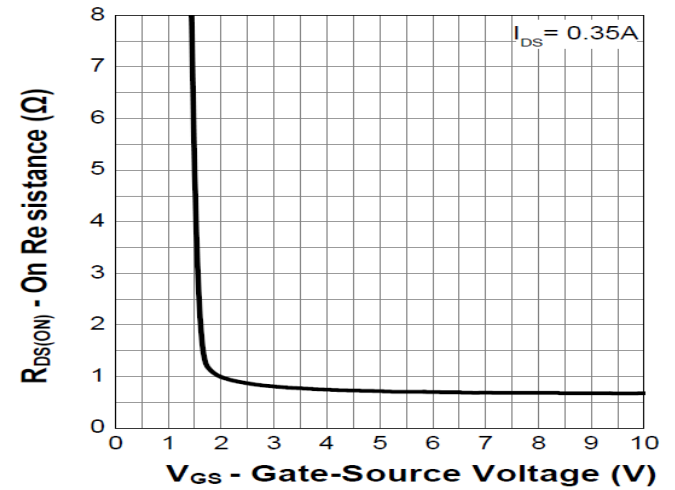

Fig. 5 on-Resistance vs. T_j

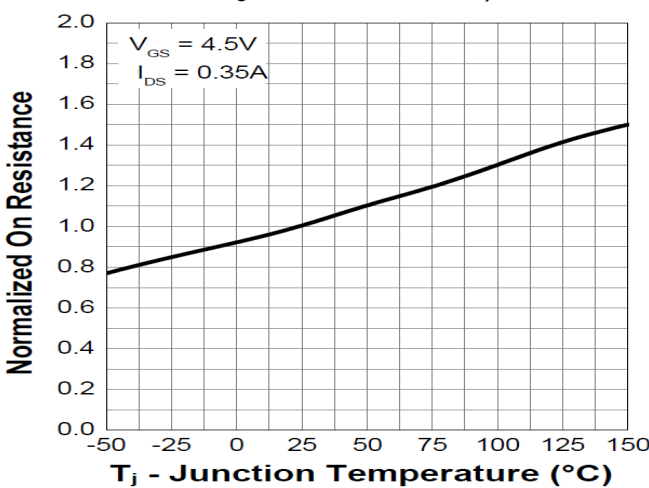
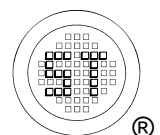
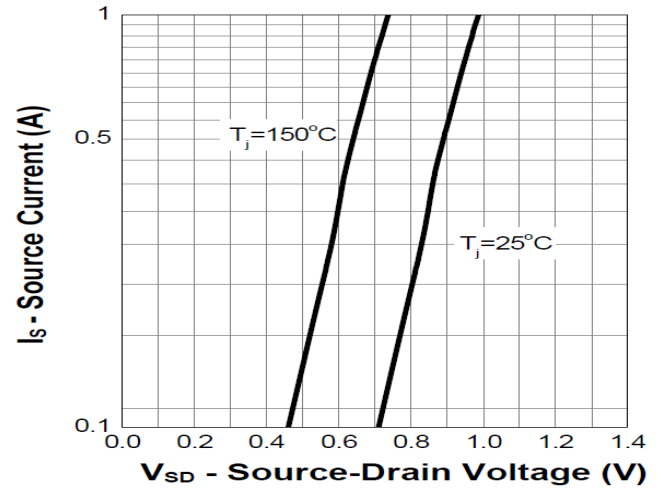

Fig. 6 Typical Forward Characteristics



MMFTX3008KDW-CH

Electrical characteristics curves (N-Channel Q1)

Fig. 7 Typical Junction Capacitance

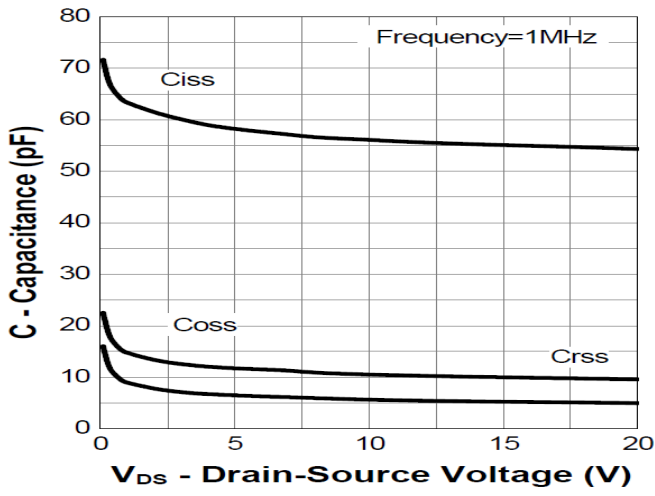
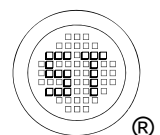
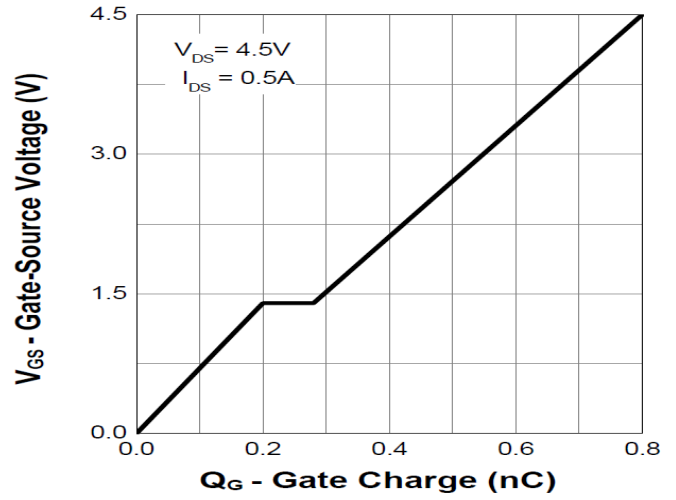

Fig. 8 Gate Charge



Electrical characteristics curves (P-Channel Q2)

Fig. 1 Typical Output Characteristics

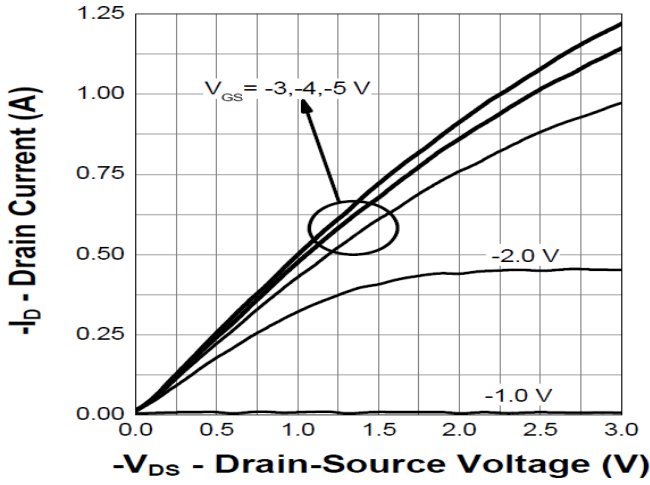

Fig. 2 Gate Threshold Variation vs. T_j

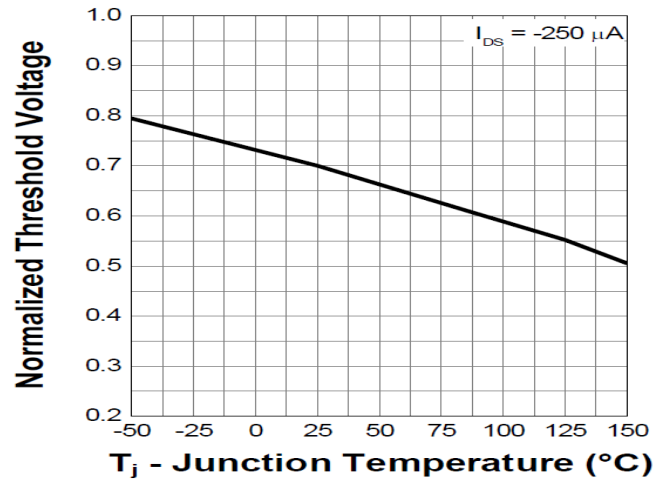

Fig. 3 on-Resistance vs. Drain Current

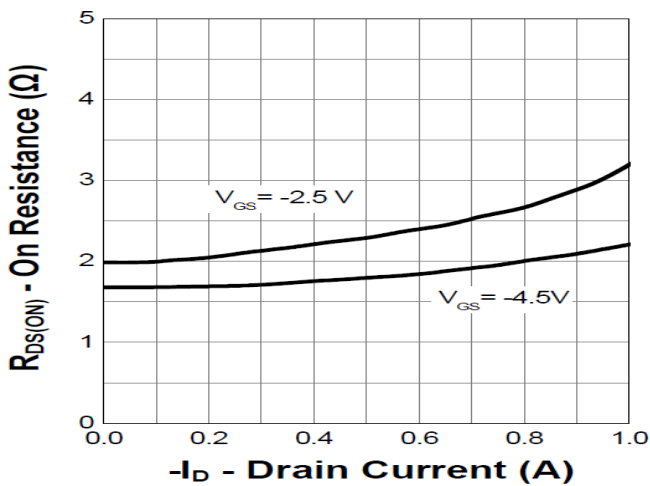

Fig. 4 on-Resistance vs. Gate-Source Voltage

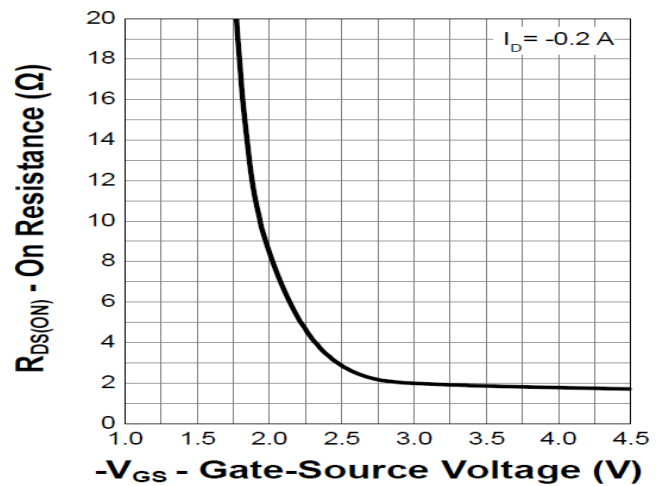

Fig. 5 on-Resistance vs. T_j

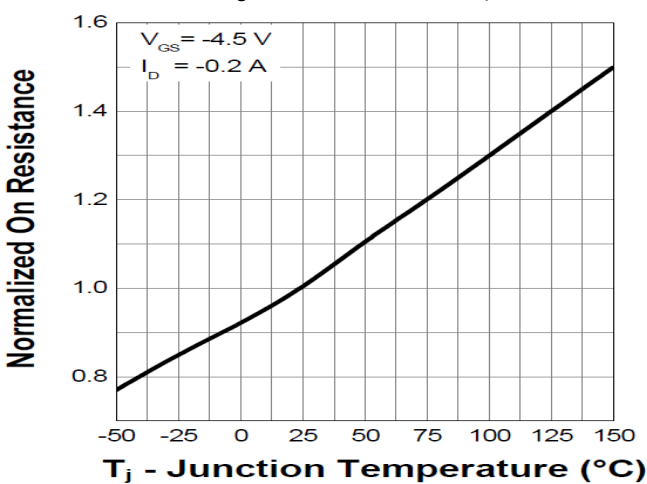
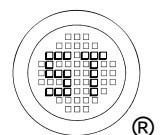
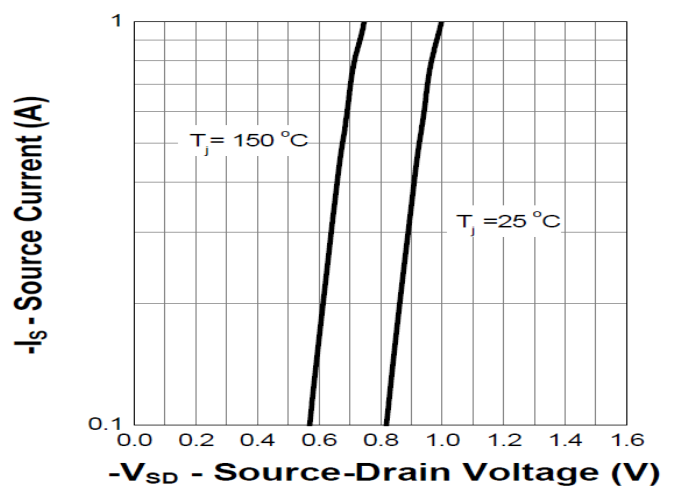

Fig. 6 Typical Forward Characteristics



MMFTX3008KDW-CH

Electrical characteristics curves (P-Channel Q2)

Fig. 7 Typical Junction Capacitance

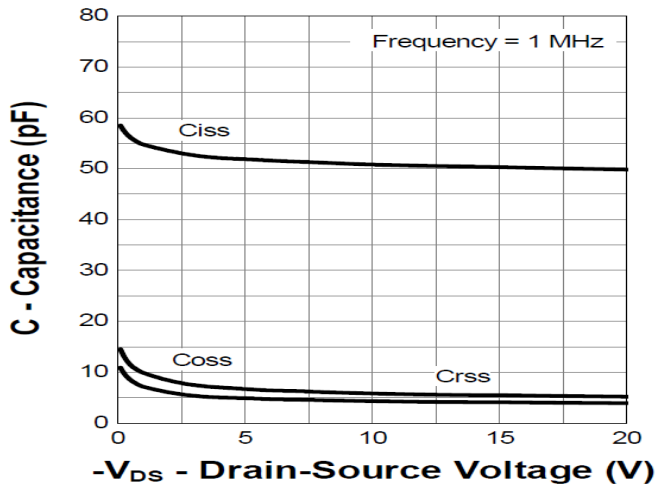
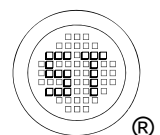
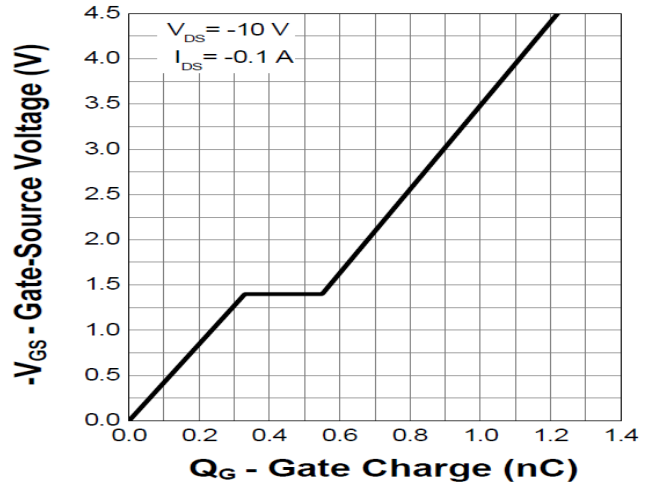

Fig. 8 Gate Charge



Test Circuits (N-Channel Q1)

Fig.1-1 Switching times test circuit

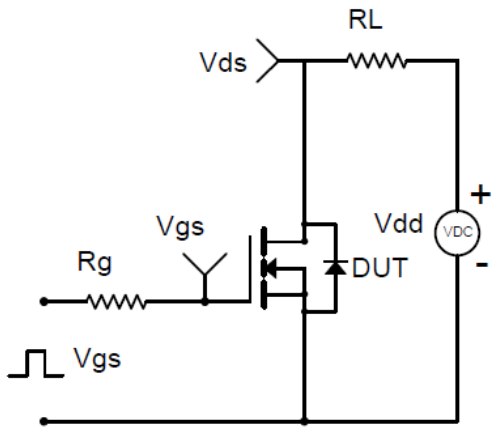

Fig.1-2 Switching Waveform

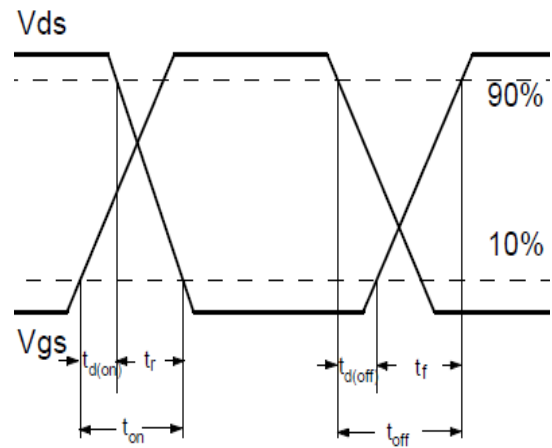

Fig.2-1 Gate charge test circuit

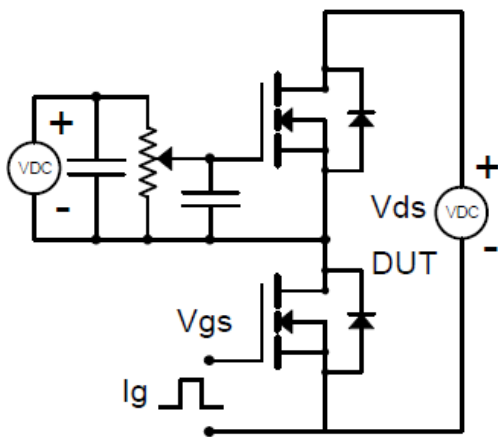
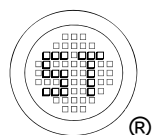
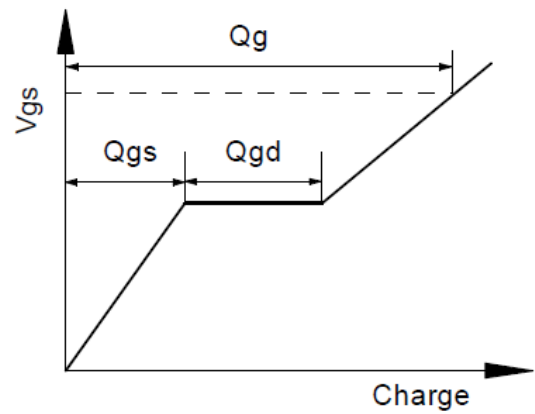

Fig.2-2 Gate charge waveform



Test Circuits (P-Channel Q2)

Fig.1-1 Switching times test circuit

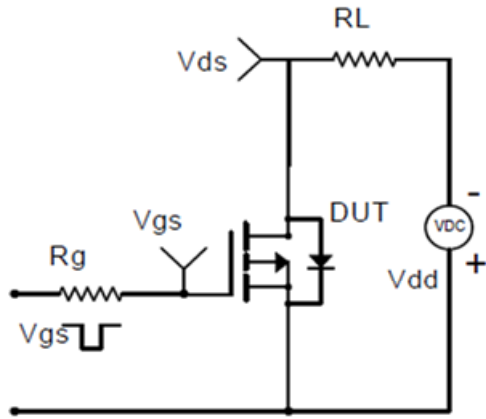

Fig.1-2 Switching Waveform

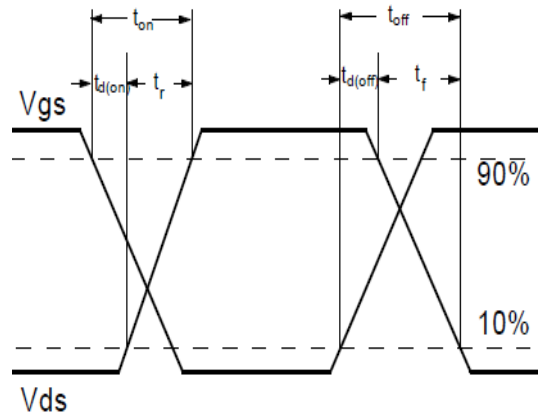

Fig.2-1 Gate charge test circuit

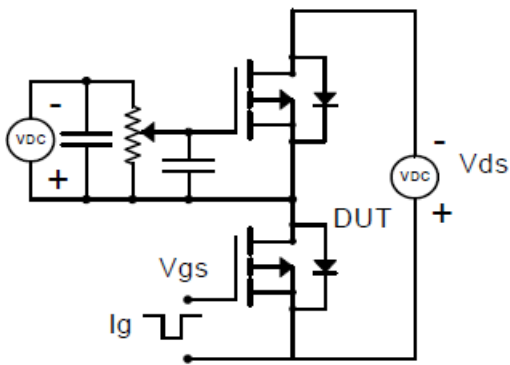
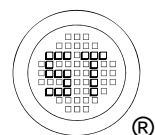
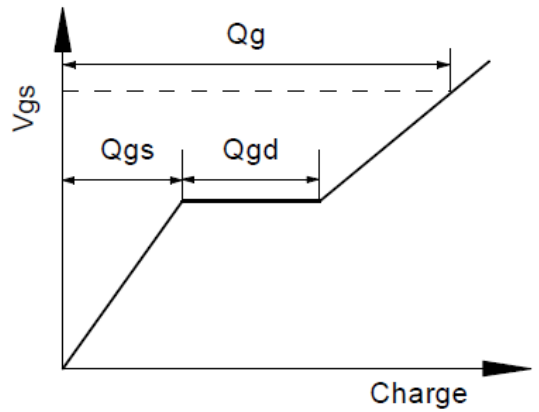

Fig.2-2 Gate charge waveform



MMFTX3008KDW-CH

Package Outline (Dimensions in mm)

SOT-363

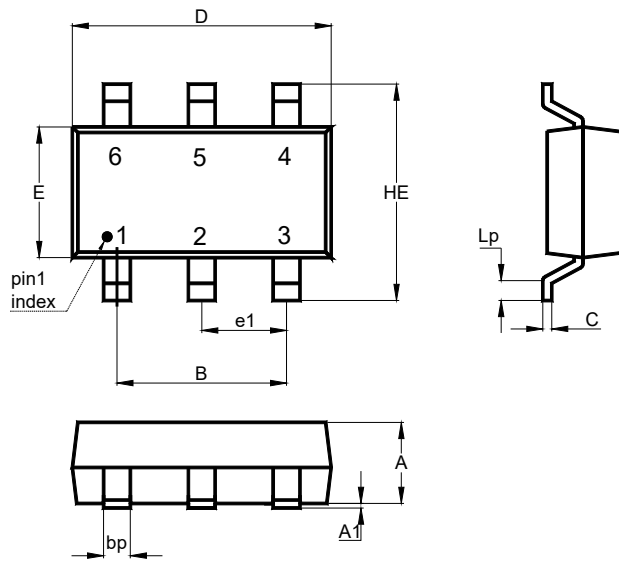

Unit	A	A1	B	C	D	E	e1	HE	Lp	bp
mm	1.0	0.1	1.3	0.25	2.2	1.35	0.65	2.2	0.4	0.3
	0.9	0	typ.	0.1	1.8	1.15	typ.	2.0	0.15	0.1

Recommended Soldering Footprint

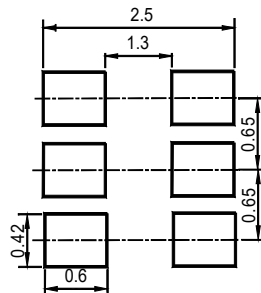

Packing information

Package	Tape Width (mm)	Pitch		Reel Size		Per Reel Packing Quantity
		mm	inch	mm	inch	
SOT-363	8	4 ± 0.1	0.157 ± 0.004	178	7	3,000

Marking information

- " MS " = Part No.
- " • " = HAF (Halogen and Antimony Free)
- " YM " = Date Code Marking
- " Y " = Year
- " M " = Month

Font type: Arial

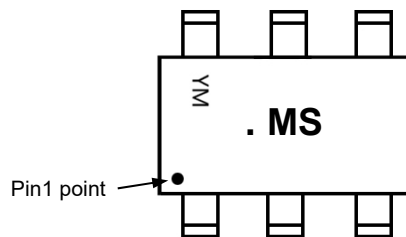

Disclaimer: Our company reserve the right to make modifications, enhancements, improvements, corrections or other changes to improve product design, functions and reliability, anytime without notice. Semtech Electronics Limited makes no warranties, representations or warranties regarding the suitability of its products for any particular purpose, and does not accept any liability arising from the application or use of any product or circuit such as: Apply to medical, military, aircraft, space or life support equipment and expressly waive any and all liability, including but not limited to special, consequential or collateral damage.

