

# MMFTP6401

## P-Channel Enhancement Mode MOSFET

### Features

- Surface-mounted package

### Application

- Portable appliances
- Low power DC to DC Converter

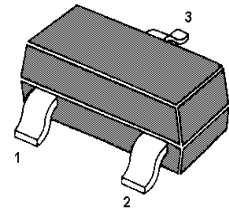
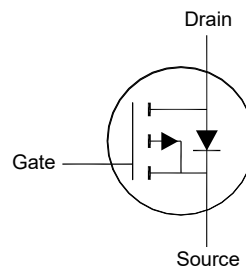

1.Gate 2.Source 3.Drain  
SOT-23 Plastic Package

### Absolute Maximum Ratings(at $T_a = 25^\circ\text{C}$ unless otherwise specified)

Parameter	Symbol	Value	Unit
Drain-Source Voltage	$-V_{DS}$	12	V
Gate-Source Voltage	$V_{GS}$	$\pm 10$	V
Drain Current	$-I_D$	4.3	A
Peak Drain Current, Pulsed <sup>1)</sup>	$-I_{DM}$	34	A
Power Dissipation <sup>2)</sup>	$P_D$	1.3	W
Operating Junction and Storage Temperature Range	$T_J, T_{stg}$	- 55 to + 150	$^\circ\text{C}$

### Thermal Resistance Ratings

Parameter	Symbol	Max.	Unit
Thermal Resistance from Junction to Ambient <sup>2)</sup>	$R_{\theta JA}$	100	$^\circ\text{C/W}$

<sup>1)</sup> Pulse Test: Pulse Width  $\leq 100 \mu\text{s}$ , Duty Cycle  $\leq 2\%$ , Repetitive rating, pulse width limited by junction temperature  $T_{J(\text{MAX})} = 150^\circ\text{C}$ .

<sup>2)</sup> Device mounted on FR-4 substrate PC board, 2oz copper, with 1-inch square copper plate in still air.

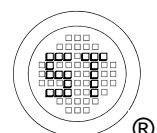

# MMFTP6401

Characteristics at  $T_a = 25^\circ\text{C}$  unless otherwise specified

Parameter	Symbol	Min.	Typ.	Max.	Unit
<b>STATIC PARAMETERS</b>					
Drain-Source Breakdown Voltage at $-I_D = 250 \mu\text{A}$	$-V_{(BR)DSS}$	12	-	-	V
Drain-Source Leakage Current at $-V_{DS} = 12 \text{ V}$	$-I_{DSS}$	-	-	1	$\mu\text{A}$
Gate Leakage Current at $V_{GS} = \pm 8 \text{ V}$	$I_{GSS}$	-	-	$\pm 100$	nA
Gate-Source Threshold Voltage at $V_{DS} = V_{GS}$ , $-I_D = 250 \mu\text{A}$	$-V_{GS(th)}$	0.4	-	0.95	V
Drain-Source On-State Resistance at $-V_{GS} = 4.5 \text{ V}$ , $-I_D = 4.3 \text{ A}$ at $-V_{GS} = 2.5 \text{ V}$ , $-I_D = 2.5 \text{ A}$ at $-V_{GS} = 1.8 \text{ V}$ , $-I_D = 2 \text{ A}$	$R_{DS(on)}$	-	-	50 85 125	m $\Omega$
<b>DYNAMIC PARAMETERS</b>					
Gate Resistance at $V_{DS} = 0 \text{ V}$ , $f = 1 \text{ MHz}$	$R_g$	-	3.6	-	$\Omega$
Forward Transconductance at $-V_{DS} = 5 \text{ V}$ , $-I_D = 4 \text{ A}$	$g_{FS}$	-	10.5	-	S
Input Capacitance at $-V_{DS} = 10 \text{ V}$ , $V_{GS} = 0 \text{ V}$ , $f = 1 \text{ MHz}$	$C_{iss}$	-	794	-	pF
Output Capacitance at $-V_{DS} = 10 \text{ V}$ , $V_{GS} = 0 \text{ V}$ , $f = 1 \text{ MHz}$	$C_{oss}$	-	92	-	pF
Reverse Transfer Capacitance at $-V_{DS} = 10 \text{ V}$ , $V_{GS} = 0 \text{ V}$ , $f = 1 \text{ MHz}$	$C_{rss}$	-	63	-	pF
Total Gate Charge at $-V_{DS} = 10 \text{ V}$ , $-I_D = 1 \text{ A}$ , $-V_{GS} = 4.5 \text{ V}$ at $-V_{DS} = 10 \text{ V}$ , $-I_D = 1 \text{ A}$ , $-V_{GS} = 2.5 \text{ V}$	$Q_g$	-	8.9 5.8	-	nC
Gate-Source Charge at $-V_{DS} = 10 \text{ V}$ , $-I_D = 1 \text{ A}$ , $-V_{GS} = 4.5 \text{ V}$	$Q_{gs}$	-	2	-	nC
Gate-Drain Charge at $-V_{DS} = 10 \text{ V}$ , $-I_D = 1 \text{ A}$ , $-V_{GS} = 4.5 \text{ V}$	$Q_{gd}$	-	2.7	-	nC
Turn-On Delay Time at $-V_{DS} = 10 \text{ V}$ , $-V_{GS} = 5 \text{ V}$ , $-I_D = 1 \text{ A}$ , $R_G = 4.7 \Omega$	$t_{d(on)}$	-	8.8	-	ns
Turn-On Rise Time at $-V_{DS} = 10 \text{ V}$ , $-V_{GS} = 5 \text{ V}$ , $-I_D = 1 \text{ A}$ , $R_G = 4.7 \Omega$	$t_r$	-	9	-	ns
Turn-Off Delay Time at $-V_{DS} = 10 \text{ V}$ , $-V_{GS} = 5 \text{ V}$ , $-I_D = 1 \text{ A}$ , $R_G = 4.7 \Omega$	$t_{d(off)}$	-	34	-	ns
Turn-Off Fall Time at $-V_{DS} = 10 \text{ V}$ , $-V_{GS} = 5 \text{ V}$ , $-I_D = 1 \text{ A}$ , $R_G = 4.7 \Omega$	$t_f$	-	18	-	ns
<b>Body-Diode PARAMETERS</b>					
Body Diode Voltage at $-I_S = 1.3 \text{ A}$ , $V_{GS} = 0 \text{ V}$	$-V_{SD}$	-	-	1.2	V
Body-Diode Continuous Current	$-I_S$	-	-	4.3	A
Body Diode Reverse Recovery Time at $-I_S = 1 \text{ A}$ , $di/dt = 100 \text{ A} / \mu\text{s}$	$t_{rr}$	-	8	-	ns
Body Diode Reverse Recovery Charge at $-I_S = 1 \text{ A}$ , $di/dt = 100 \text{ A} / \mu\text{s}$	$Q_{rr}$	-	2.3	-	nC

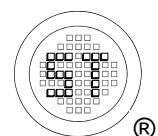

## Electrical Characteristics Curves

Fig. 1 Typical Output Characteristics

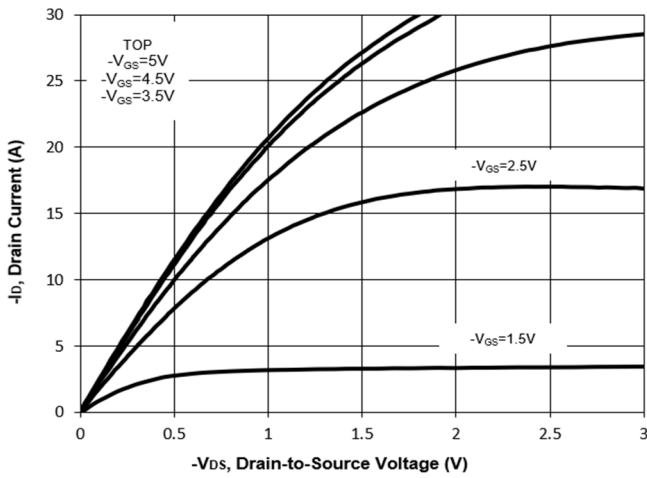

Fig. 2 Typical Transfer Characteristics

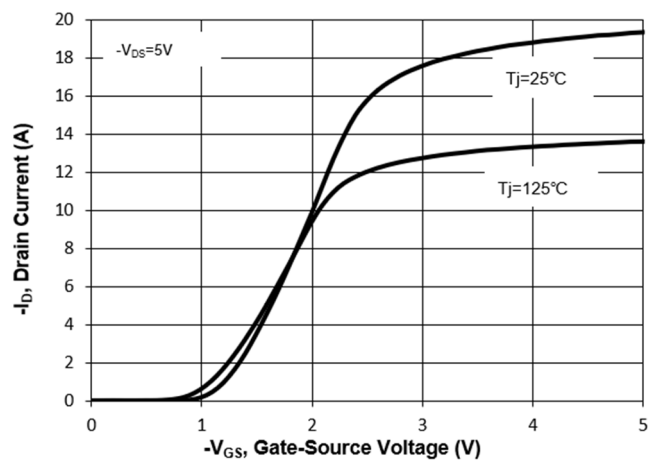

Fig. 3 on-Resistance vs. Drain Current

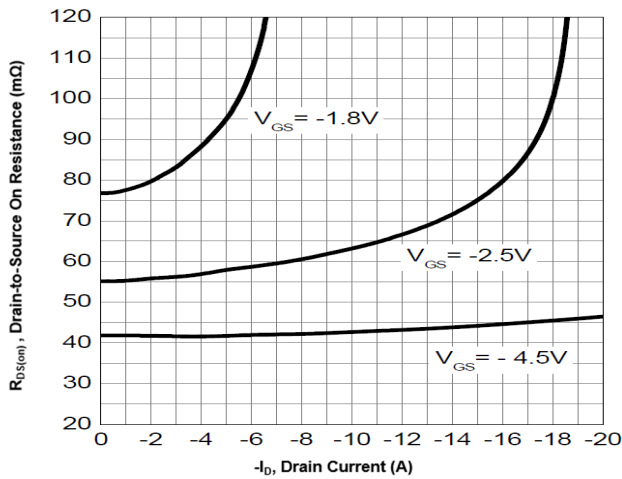

Fig. 4 on-Resistance vs. Gate Voltage

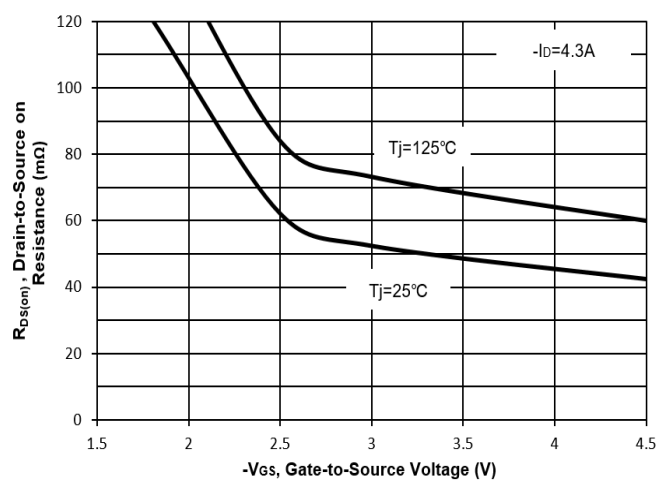

Fig. 5 on-Resistance vs. Tj

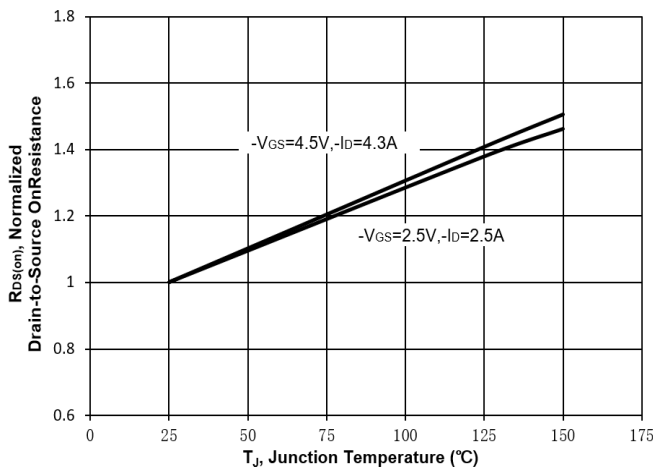
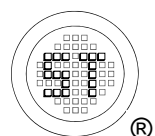
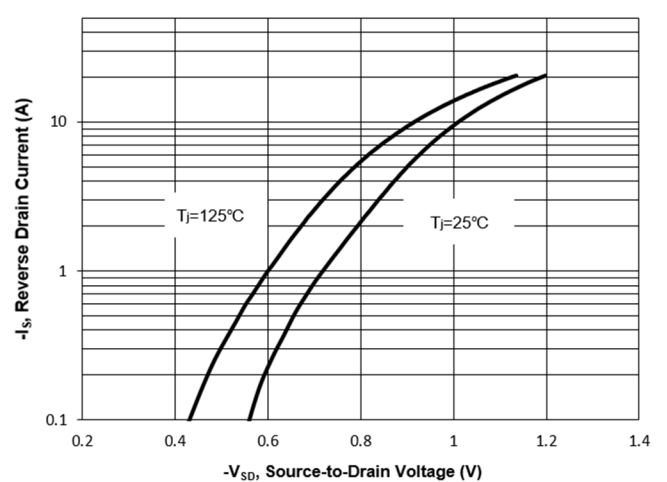

Fig. 6 Typical Forward Characteristics



## Electrical Characteristics Curves

Fig. 7 Typical Junction Capacitance

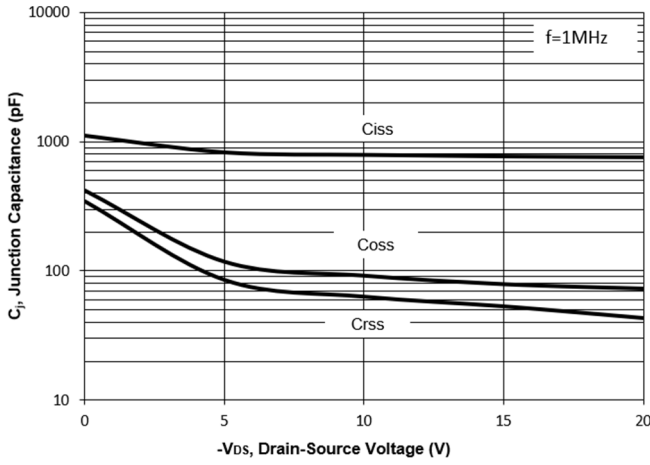

Fig. 8 Drain-Source Leakage Current vs.  $T_j$

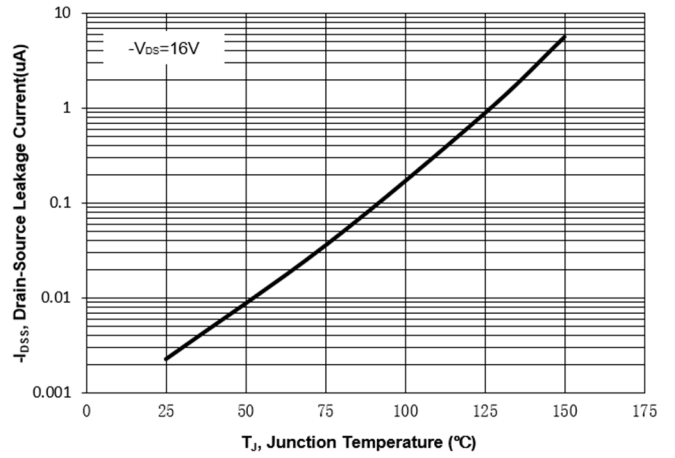

Fig. 9  $V_{(BR)DSS}$  vs. Junction Temperature

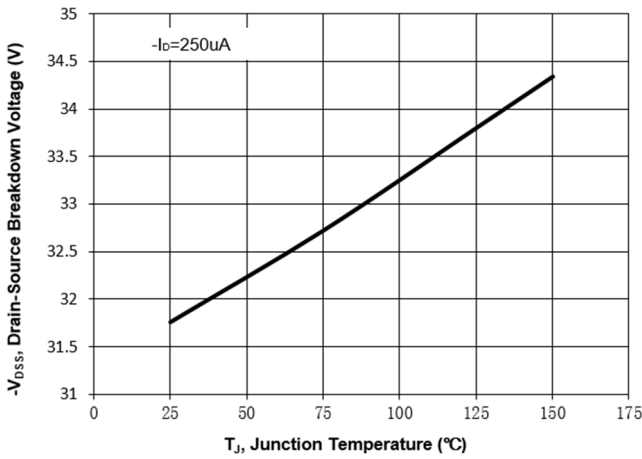

Fig. 10 Gate Threshold Variation vs.  $T_j$

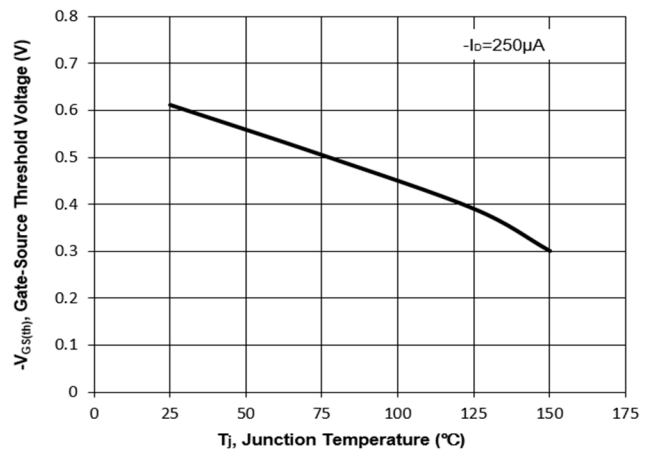
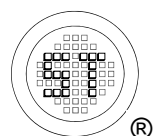
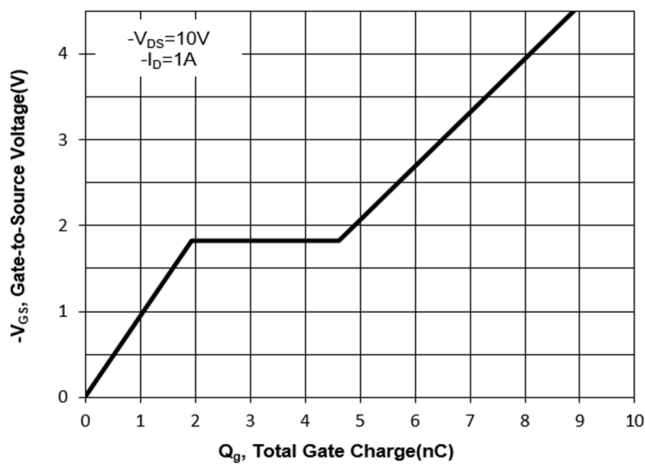

Fig. 11 Gate Charge



Test Circuits

Fig.1-1 Switching times test circuit

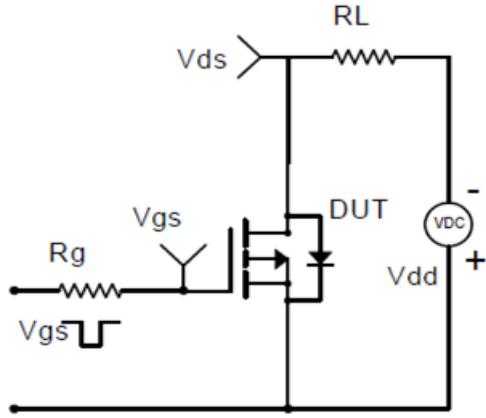

Fig.1-2 Switching Waveform

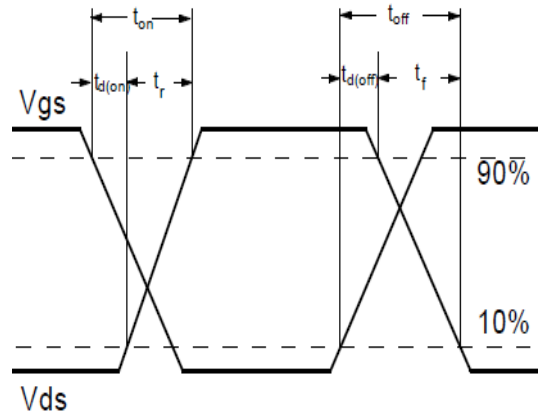

Fig.2-1 Gate charge test circuit

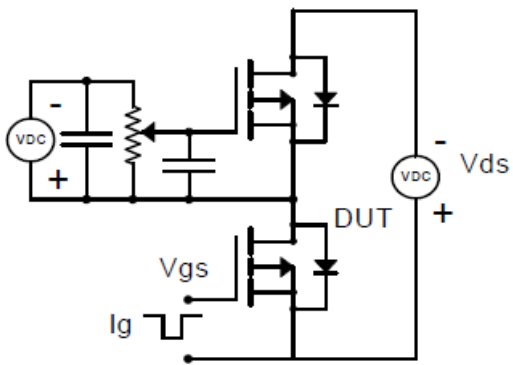
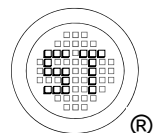
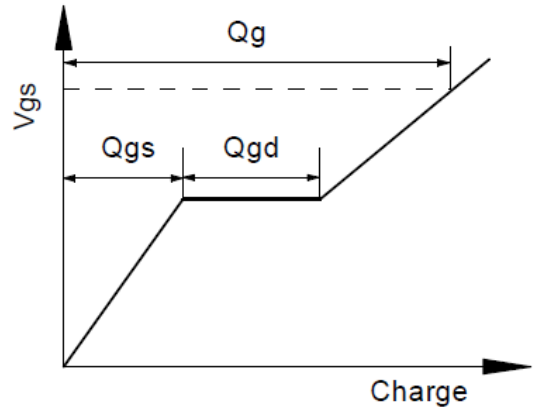

Fig.2-2 Gate charge waveform



# MMFTP6401

## Package Outline (Dimensions in mm)

SOT-23

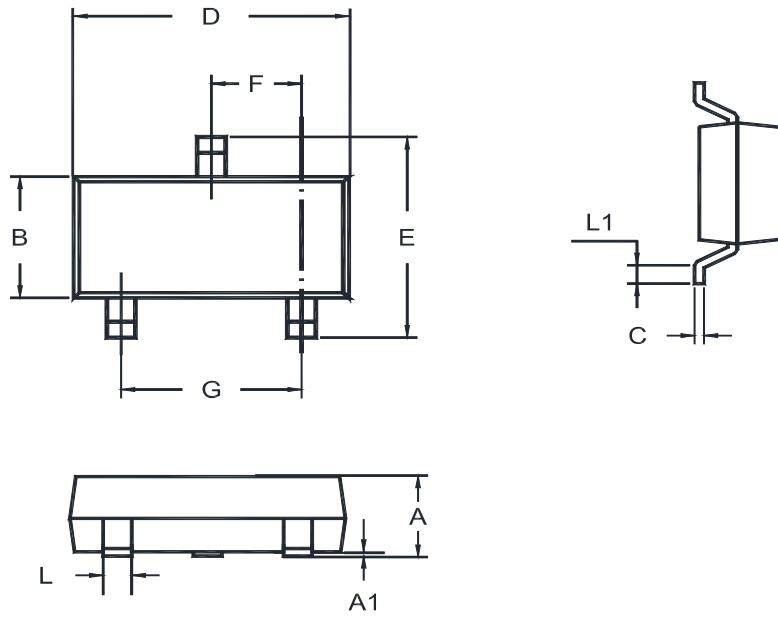

Unit	A	A1	B	C	D	E	F	G	L	L1
mm	1.20	0.100	1.40	0.19	3.04	2.6	1.02	2.04	0.51	0.2
	0.89	0.013	1.20	0.08	2.80	2.2	0.89	1.78	0.37	MIN

## Recommended Soldering Footprint

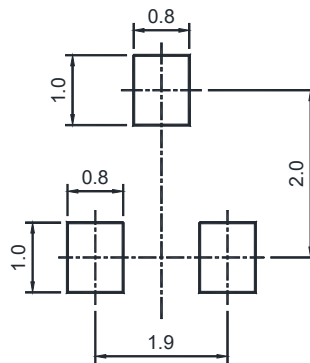

## Packing information

Package	Tape Width (mm)	Pitch		Reel Size		Per Reel Packing Quantity
		mm	inch	mm	inch	
SOT-23	8	4 ± 0.1	0.157 ± 0.004	178	7	3,000

## Marking information

- " WE " = Part No.
- "YM" = Date Code Marking
- "Y" = Year
- "M" = Month
- Font type: Arial

