

# MMFTN3402

## N-Channel Enhancement Mode MOSFET

### Features

- Surface-mounted package
- Advanced trench cell design

### Applications

- Portable appliances
- Battery management

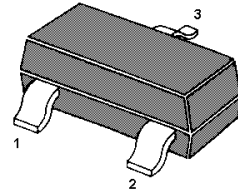
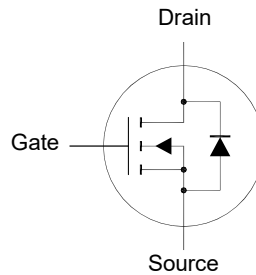

1. Gate 2. Source 3. Drain  
SOT-23 Plastic Package

### Absolute Maximum Ratings ( $T_a = 25^\circ\text{C}$ unless otherwise specified)

Parameter	Symbol	Value	Unit
Drain-Source Voltage	$V_{DS}$	30	V
Drain-Gate Voltage	$V_{GS}$	$\pm 12$	V
Drain Current - Continuous	$I_D$	4	A
Drain Current - Pulsed <sup>1)</sup>	$I_{DM}$	15	A
Power Dissipation <sup>2)</sup>	$P_D$	1	W
Power Dissipation <sup>3)</sup> Steady State	$P_D$	0.35	W
Operating Junction and Temperature	$T_j$	150	$^\circ\text{C}$
Storage Temperature Range	$T_{stg}$	- 55 to + 150	$^\circ\text{C}$

### Thermal Resistance Ratings

Parameter	Symbol	Max.	Unit
Thermal Resistance from Junction to Ambient <sup>2)</sup>	$R_{\theta JA}$	125	$^\circ\text{C}/\text{W}$
Thermal Resistance from Junction to Ambient <sup>3)</sup> Steady State	$R_{\theta JA}$	357	$^\circ\text{C}/\text{W}$

<sup>1)</sup> Pulse Test: Pulse Width  $\leq 100 \mu\text{s}$ , Duty Cycle  $\leq 2\%$ , Repetitive rating, pulse width limited by junction temperature  $T_{j(\text{MAX})} = 150^\circ\text{C}$ .

<sup>2)</sup> Device mounted on FR-4 substrate PC board, 2oz copper, with 1-inch square copper plate,  $t \leq 10 \text{ s}$ .

<sup>3)</sup> Device mounted on FR-4 substrate PC board, 2oz copper, with minimum recommended pad layout.

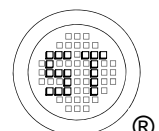

# MMFTN3402

## Characteristics at $T_a = 25^\circ\text{C}$ unless otherwise specified

Parameter	Symbol	Min.	Typ.	Max.	Unit
<b>STATIC PARAMETERS</b>					
Drain-Source Breakdown Voltage at $I_D = 250 \mu\text{A}$	$V_{(BR)DSS}$	30	-	-	V
Drain-Source Leakage Current at $V_{DS} = 24 \text{ V}$	$I_{DSS}$	-	-	1	$\mu\text{A}$
Gate-Source Leakage Current at $V_{GS} = \pm 12 \text{ V}$	$I_{GSS}$	-	-	$\pm 100$	nA
Gate-Source Threshold Voltage at $V_{GS} = V_{DS}, I_D = 250 \mu\text{A}$	$V_{GS(th)}$	0.6	-	1.4	V
Drain-Source On-State Resistance at $V_{GS} = 10 \text{ V}, I_D = 4 \text{ A}$ at $V_{GS} = 4.5 \text{ V}, I_D = 3 \text{ A}$ at $V_{GS} = 2.5 \text{ V}, I_D = 2 \text{ A}$	$R_{DS(on)}$	-	-	55 70 110	$\text{m}\Omega$
<b>DYNAMIC PARAMETERS</b>					
Gate Resistance at $V_{DS} = 0 \text{ V}, V_{GS} = 0 \text{ V}, f = 1 \text{ MHz}$	$R_g$	-	5.9	-	$\Omega$
Forward Transconductance at $V_{DS} = 5 \text{ V}, I_D = 4 \text{ A}$	$g_{fs}$	-	12	-	S
Input Capacitance at $V_{GS} = 0 \text{ V}, V_{DS} = 15 \text{ V}, f = 1 \text{ MHz}$	$C_{iss}$	-	505	-	pF
Output Capacitance at $V_{GS} = 0 \text{ V}, V_{DS} = 15 \text{ V}, f = 1 \text{ MHz}$	$C_{oss}$	-	61	-	pF
Reverse Transfer Capacitance at $V_{GS} = 0 \text{ V}, V_{DS} = 15 \text{ V}, f = 1 \text{ MHz}$	$C_{rss}$	-	50	-	pF
Total Gate Charge at $V_{DS} = 15 \text{ V}, I_D = 4 \text{ A}, V_{GS} = 10 \text{ V}$ at $V_{DS} = 15 \text{ V}, I_D = 4 \text{ A}, V_{GS} = 4.5 \text{ V}$	$Q_g$	-	11.5 5.3	-	nC
Gate Source Charge at $V_{DS} = 15 \text{ V}, I_D = 4 \text{ A}, V_{GS} = 10 \text{ V}$	$Q_{gs}$	-	1.4	-	nC
Gate Drain Charge at $V_{DS} = 15 \text{ V}, I_D = 4 \text{ A}, V_{GS} = 10 \text{ V}$	$Q_{gd}$	-	1.6	-	nC
Turn-On Delay Time at $V_{DD} = 15 \text{ V}, V_{GS} = 10 \text{ V}, I_D = 1 \text{ A}, R_g = 1 \Omega$	$t_{d(on)}$	-	7	-	nS
Turn-On Rise Time at $V_{DD} = 15 \text{ V}, V_{GS} = 10 \text{ V}, I_D = 1 \text{ A}, R_g = 1 \Omega$	$t_r$	-	3.6	-	nS
Turn-Off Delay Time at $V_{DD} = 15 \text{ V}, V_{GS} = 10 \text{ V}, I_D = 1 \text{ A}, R_g = 1 \Omega$	$t_{d(off)}$	-	12	-	nS
Turn-Off Fall Time at $V_{DD} = 15 \text{ V}, V_{GS} = 10 \text{ V}, I_D = 1 \text{ A}, R_g = 1 \Omega$	$t_f$	-	5	-	nS
<b>Body-Diode PARAMETERS</b>					
Drain-Source Diode Forward Voltage at $I_S = 1 \text{ A}, V_{GS} = 0 \text{ V}$	$V_{SD}$	-	-	1	V
Body-Diode Continuous Current	$I_S$	-	-	4	A
Body Diode Reverse Recovery Time at $I_S = 1 \text{ A}, di/dt = 100 \text{ A} / \mu\text{s}$	$t_{rr}$	-	7.4	-	nS
Body Diode Reverse Recovery Charge at $I_S = 1 \text{ A}, di/dt = 100 \text{ A} / \mu\text{s}$	$Q_{rr}$	-	2.2	-	nC

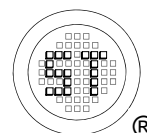

## Electrical Characteristics Curves

Fig. 1 Typical Output Characteristics

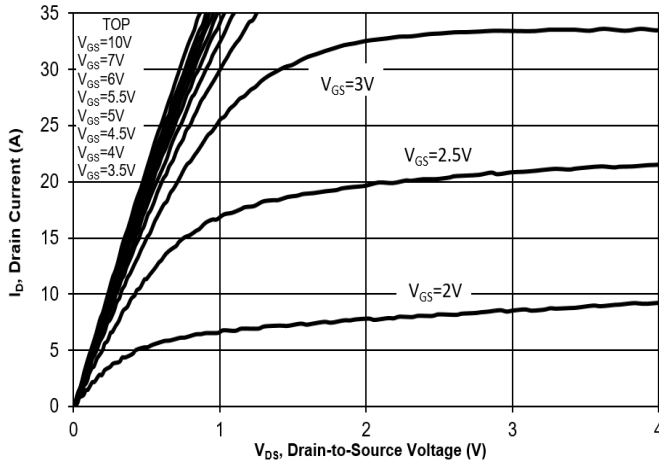

Fig. 2 Typical Transfer Characteristics

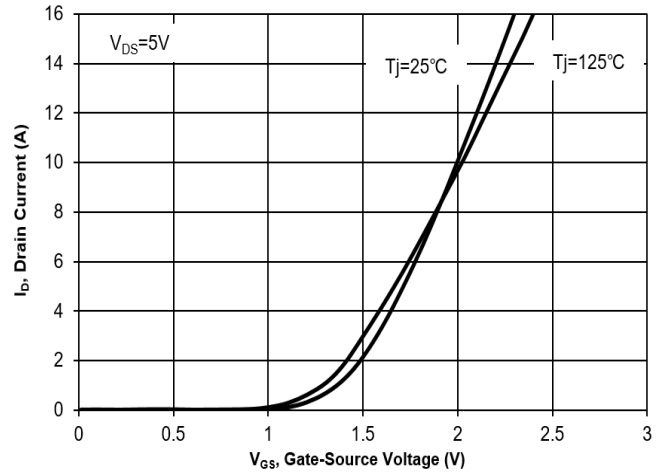

Fig. 3 on-Resistance vs. Drain Current

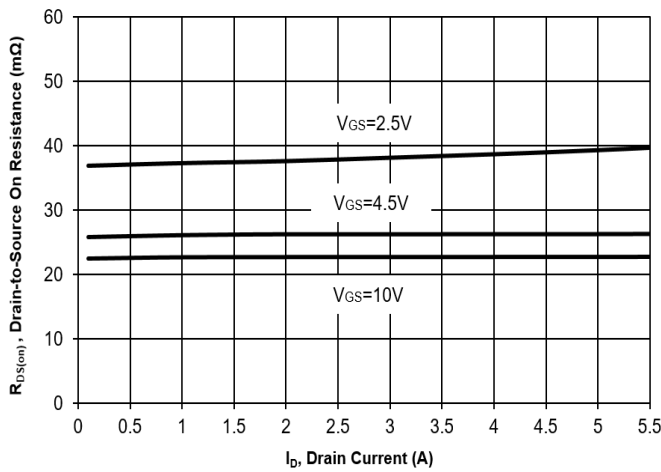

Fig. 4 on-Resistance vs. Gate Voltage

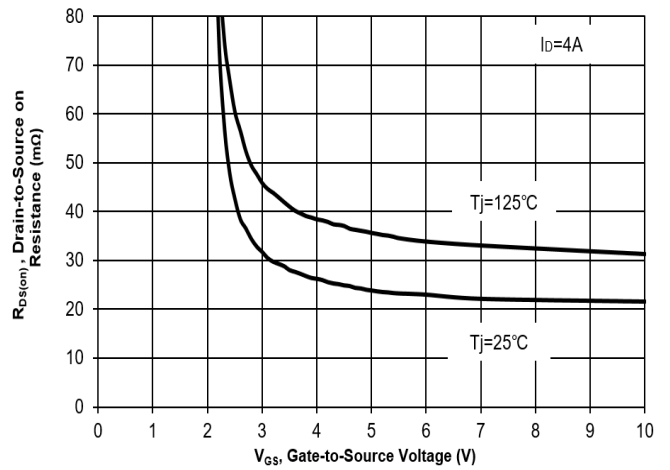

Fig. 5 on-Resistance vs.  $T_J$

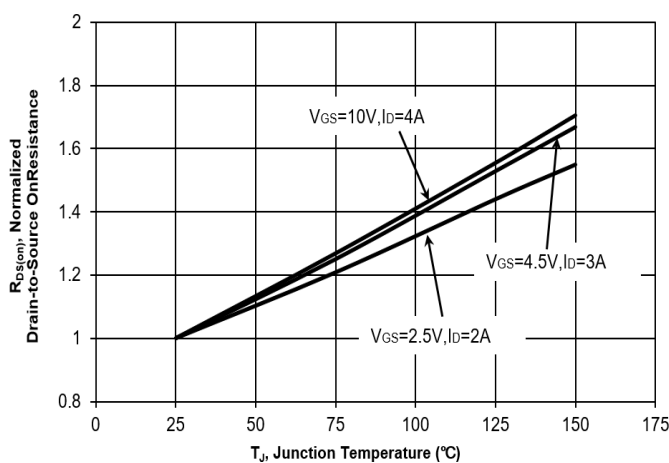
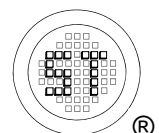
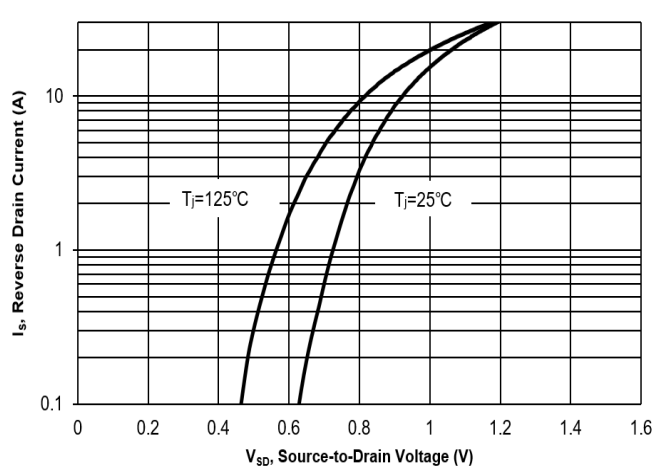

Fig. 6 Body Diodes Forward Characteristics



## Electrical Characteristics Curves

Fig. 7 Typical Junction Capacitance

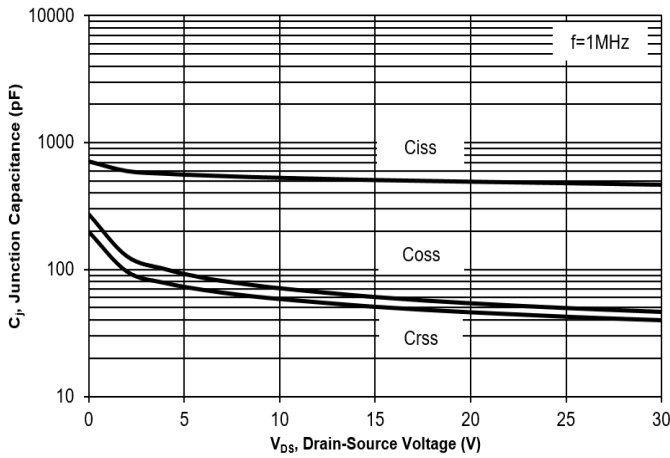

Fig. 8 Drain-Source Leakage Current vs.  $T_j$

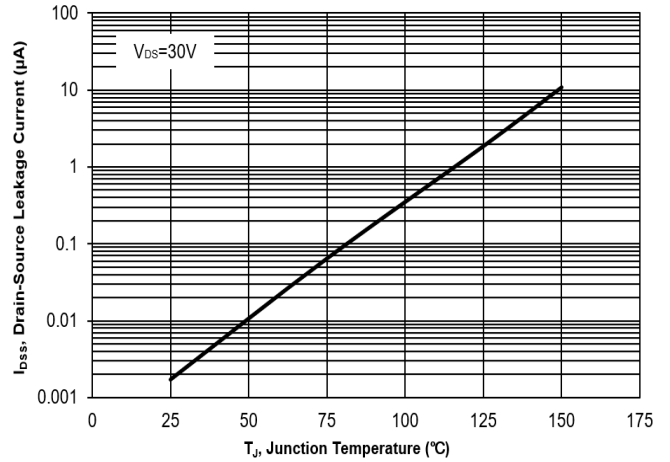

Fig. 9  $V_{(BR)DSS}$  vs. Junction Temperature

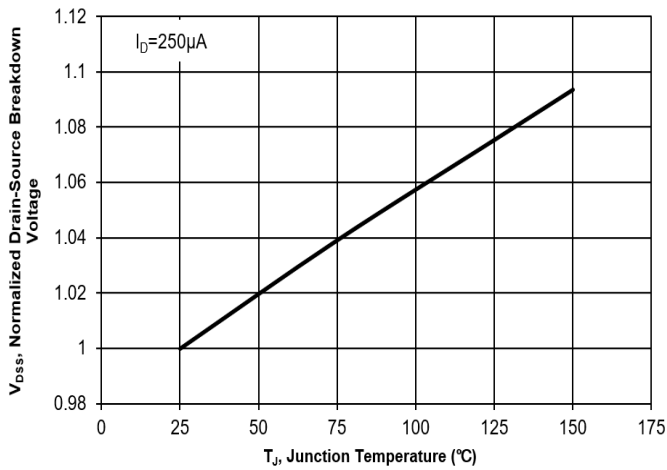

Fig. 10 Gate Threshold Variation vs.  $T_j$

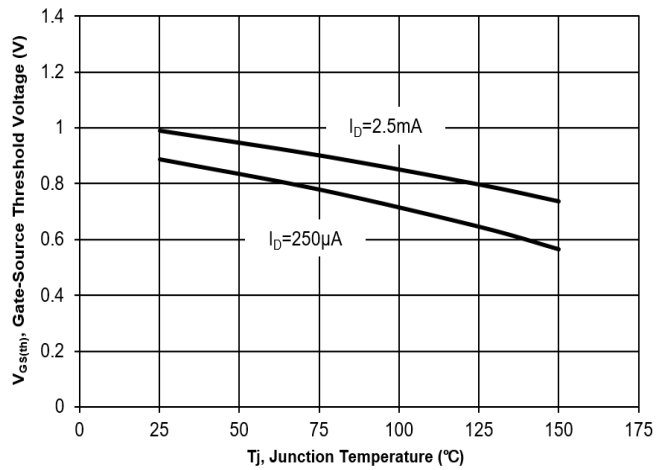
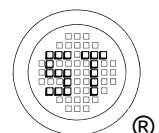
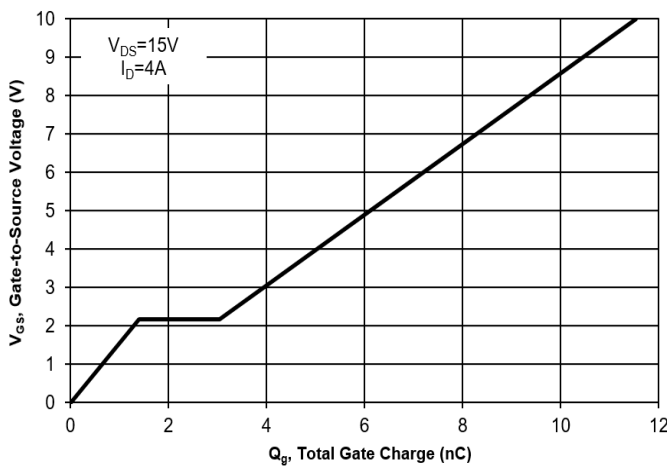

Fig. 11 Gate Charge



## Test Circuits

Fig.1-1 Switching times test circuit

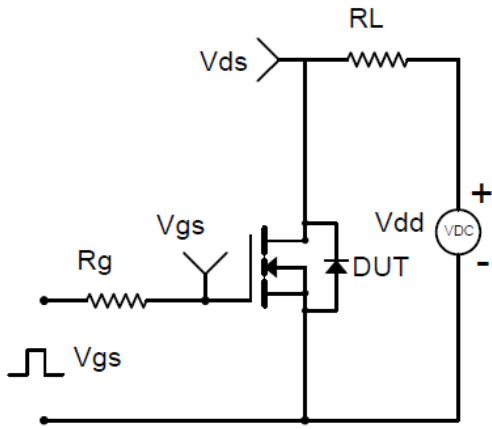

Fig.1-2 Switching Waveform

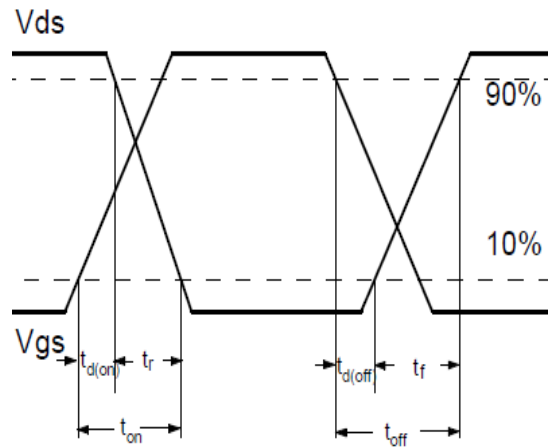

Fig.2-1 Gate charge test circuit

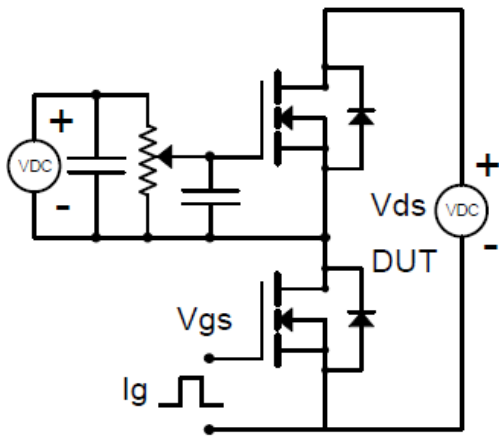
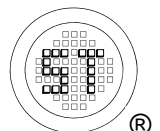
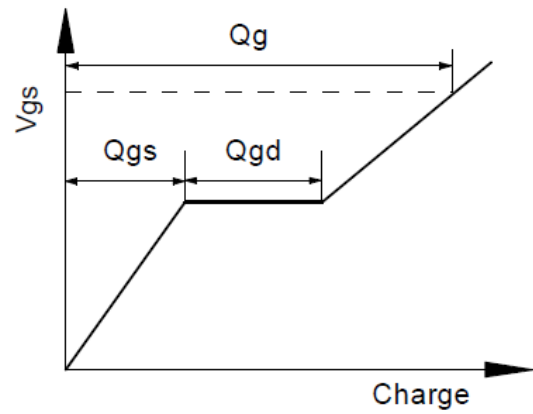

Fig.2-2 Gate charge waveform



# MMFTN3402

## Package Outline (Dimensions in mm)

SOT-23

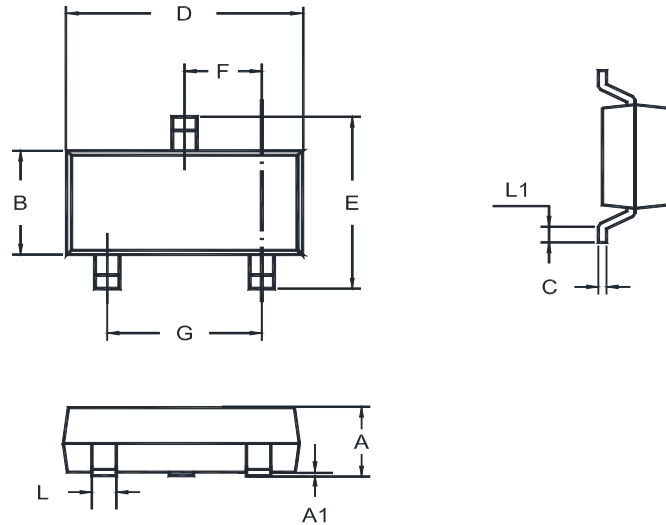

Unit	A	A1	B	C	D	E	F	G	L	L1
mm	1.20	0.100	1.40	0.19	3.04	2.6	1.02	2.04	0.51	0.2
	0.89	0.013	1.20	0.08	2.80	2.2	0.89	1.78	0.37	MIN

## Recommended Soldering Footprint

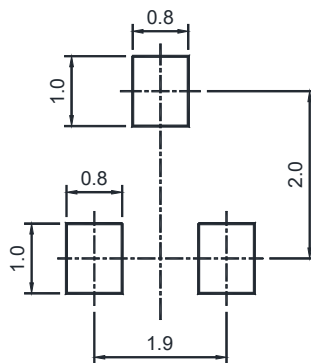

## Packing information

Package	Tape Width (mm)	Pitch		Reel Size		Per Reel Packing Quantity
		mm	inch	mm	inch	
SOT-23	8	4 ± 0.1	0.157 ± 0.004	178	7	3,000

## Marking information

- " WC " = Part No.
  - " YM " = Date Code Marking
  - " Y " = Year
  - " M " = Month
- Font type: Arial

