

MMFTN2308K

N-Channel Enhancement Mode MOSFET

Features

- Built-in G-S Protection Diode
- Typical ESD Protection HBM Class 1C

Classification	Voltage Range(V)
0A	< 125
0B	125 to < 250
1A	250 to < 500
1B	500 to < 1000
1C	1000 to < 2000
2	2000 to < 4000
3A	4000 to < 8000
3B	≥ 8000

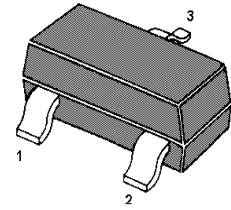
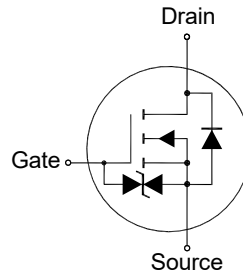

1. Gate 2. Source 3. Drain
SOT-23 Plastic Package

Applications

- Portable appliances
- Battery management
- High speed switch
- Low power DC to DC Converter

Absolute Maximum Ratings (at $T_a = 25^\circ\text{C}$ unless otherwise specified)

Parameter	Symbol	Value	Unit
Drain-Source Voltage	V_{DS}	60	V
Gate-Source Voltage	V_{GS}	± 20	V
Continuous Drain Current	I_D	1.9	A
Peak Drain Current , Pulsed ¹⁾	I_{DM}	8	A
Power Dissipation ²⁾	P_D	1.1	W
Operating Junction Temperature Range	T_j	- 55 to + 150	$^\circ\text{C}$
Storage Temperature Range	T_{stg}	- 55 to + 150	$^\circ\text{C}$

Thermal Characteristics

Parameter	Symbol	Max.	Unit
Thermal Resistance from Junction to Ambient ²⁾ $t \leq 10$ s Steady State	$R_{\theta JA}$	115 130	$^\circ\text{C}/\text{W}$

¹⁾ Pulse Test: Pulse Width $\leq 100 \mu\text{s}$, Duty Cycle $\leq 2\%$, Repetitive rating, pulse width limited by junction temperature $T_{j(\text{MAX})} = 150^\circ\text{C}$.

²⁾ Device mounted on FR-4 substrate PC board, 2oz copper, with 1-inch square copper plate in still air.

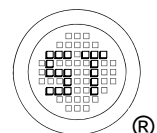

MMFTN2308K

Characteristics at $T_a = 25^\circ\text{C}$ unless otherwise specified

Parameter	Symbol	Min.	Typ.	Max.	Unit
STATIC PARAMETERS					
Drain-Source Breakdown Voltage at $I_D = 250 \mu\text{A}$	$V_{(BR)DSS}$	60	-	-	V
Zero Gate Voltage Drain Current at $V_{DS} = 60 \text{ V}$	I_{DSS}	-	-	1	μA
Gate-Source Leakage at $V_{GS} = \pm 20 \text{ V}$	I_{GSS}	-	-	± 10	μA
Gate-Source Threshold Voltage at $V_{DS} = V_{GS}$, $I_D = 250 \mu\text{A}$	$V_{GS(th)}$	1	-	3	V
Drain-Source On-State Resistance at $V_{GS} = 10 \text{ V}$, $I_D = 1.9 \text{ A}$ at $V_{GS} = 4.5 \text{ V}$, $I_D = 1.7 \text{ A}$	$R_{DS(on)}$	- -	- -	156 192	$\text{m}\Omega$
DYNAMIC PARAMETERS					
Forward Transconductance at $V_{DS} = 5 \text{ V}$, $I_D = 2 \text{ A}$	g_{fs}	-	4.8	-	S
Gate Resistance at $V_{GS} = 0 \text{ V}$, $V_{DS} = 0 \text{ V}$, $f = 1 \text{ MHz}$	R_g	-	5.7	-	Ω
Input Capacitance at $V_{GS} = 0 \text{ V}$, $V_{DS} = 30 \text{ V}$, $f = 1 \text{ MHz}$	C_{iss}	-	310	-	pF
Output Capacitance at $V_{GS} = 0 \text{ V}$, $V_{DS} = 30 \text{ V}$, $f = 1 \text{ MHz}$	C_{oss}	-	23.8	-	pF
Reverse Transfer Capacitance at $V_{GS} = 0 \text{ V}$, $V_{DS} = 30 \text{ V}$, $f = 1 \text{ MHz}$	C_{rss}	-	18	-	pF
Total Gate Charge at $V_{DS} = 30 \text{ V}$, $V_{GS} = 10 \text{ V}$, $I_D = 2 \text{ A}$ at $V_{DS} = 30 \text{ V}$, $V_{GS} = 4.5 \text{ V}$, $I_D = 2 \text{ A}$	Q_g	- -	6.8 3.3	- -	nC
Gate-Source Charge at $V_{DS} = 30 \text{ V}$, $V_{GS} = 10 \text{ V}$, $I_D = 2 \text{ A}$	Q_{gs}	-	1.3	-	nC
Gate-Drain Charge at $V_{DS} = 30 \text{ V}$, $V_{GS} = 10 \text{ V}$, $I_D = 2 \text{ A}$	Q_{gd}	-	1	-	nC
Turn-On Delay Time at $V_{DS} = 30 \text{ V}$, $V_{GS} = 10 \text{ V}$, $I_D = 2 \text{ A}$, $R_g = 3.9 \Omega$	$t_{d(on)}$	-	5	-	nS
Turn-On Rise Time at $V_{DS} = 30 \text{ V}$, $V_{GS} = 10 \text{ V}$, $I_D = 2 \text{ A}$, $R_g = 3.9 \Omega$	t_r	-	2	-	nS
Turn-Off Delay Time at $V_{DS} = 30 \text{ V}$, $V_{GS} = 10 \text{ V}$, $I_D = 2 \text{ A}$, $R_g = 3.9 \Omega$	$t_{d(off)}$	-	7	-	nS
Turn-Off Fall Time at $V_{DS} = 30 \text{ V}$, $V_{GS} = 10 \text{ V}$, $I_D = 2 \text{ A}$, $R_g = 3.9 \Omega$	t_f	-	6	-	nS
Body-Diode PARAMETERS					
Drain-Source Diode Forward Voltage at $I_S = 1 \text{ A}$	V_{SD}	-	-	1.2	V
Body Diodes Continuous Current	I_S	-	-	1.9	A
Body Diode Reverse Recovery Time at $I_S = 2 \text{ A}$, $di/dt = 100 \text{ A} / \mu\text{s}$	t_{rr}	-	7.8	-	nS
Body Diode Reverse Recovery Charge at $I_S = 2 \text{ A}$, $di/dt = 100 \text{ A} / \mu\text{s}$	Q_{rr}	-	4	-	nC

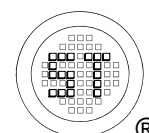

MMFTN2308K

Electrical Characteristics Curves

Fig. 1 Typical Output Characteristics

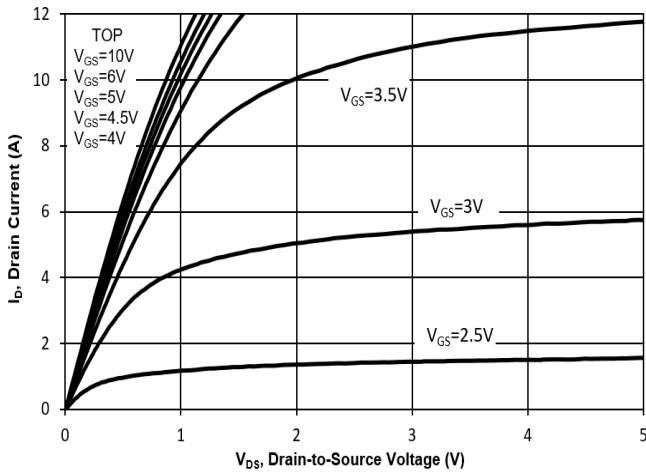

Fig. 2 Typical Transfer Characteristics

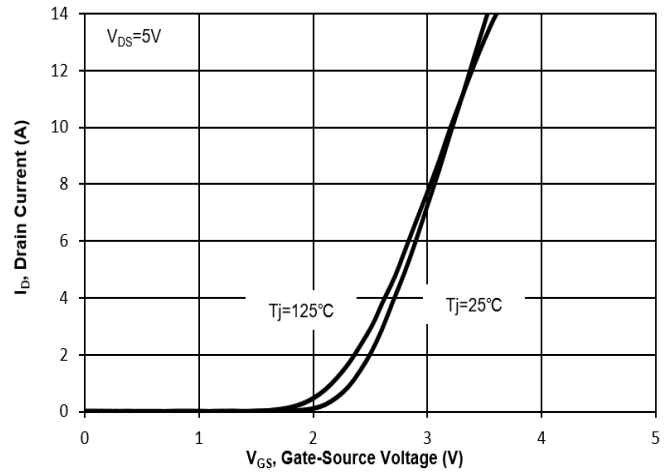

Fig. 3 On-Resistance vs. Drain Current

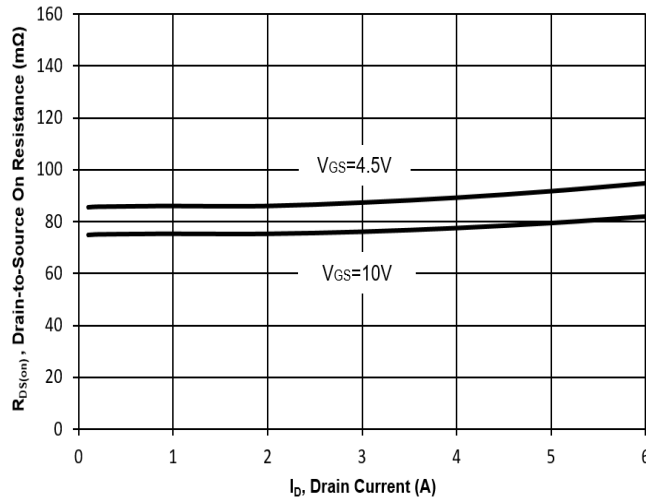

Fig. 4 On-Resistance vs. Gate-Source Voltage

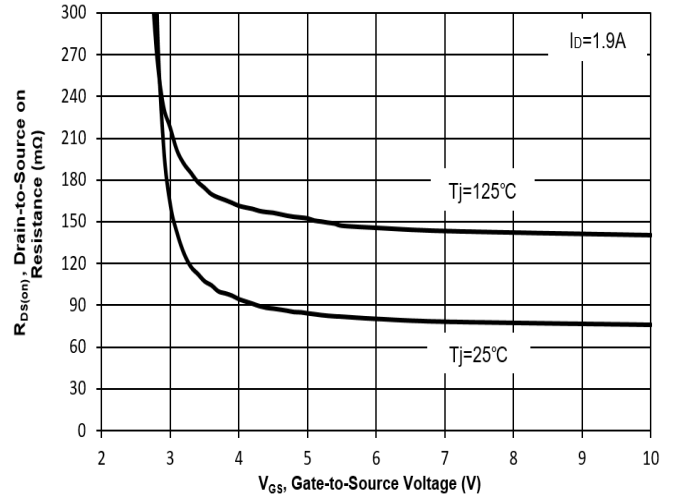

Fig. 5 On-Resistance vs. T_J

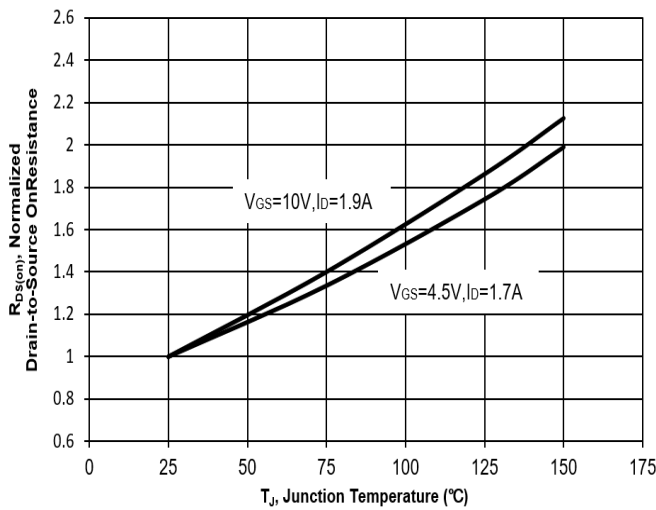
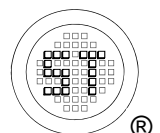
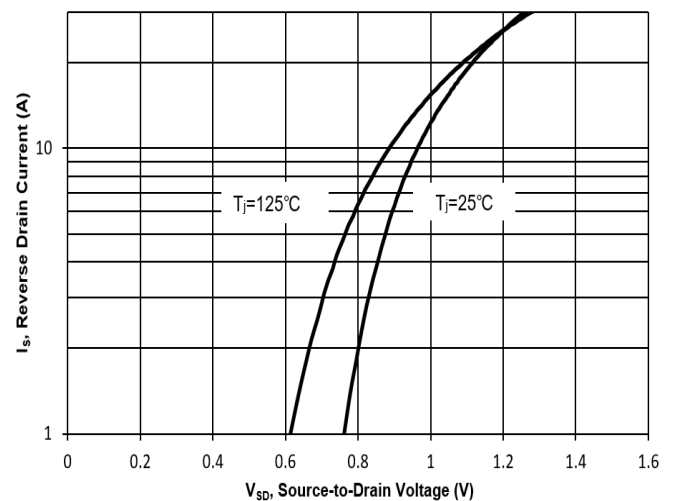

Fig. 6 Typical Body-Diode Forward Characteristics



MMFTN2308K

Electrical Characteristics Curves

Fig. 7 Typical Junction Capacitance

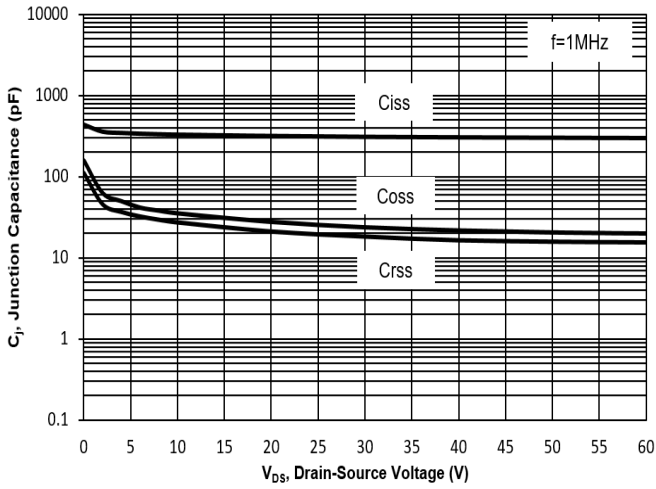

Fig. 8 Drain-Source Leakage Current vs. T_j

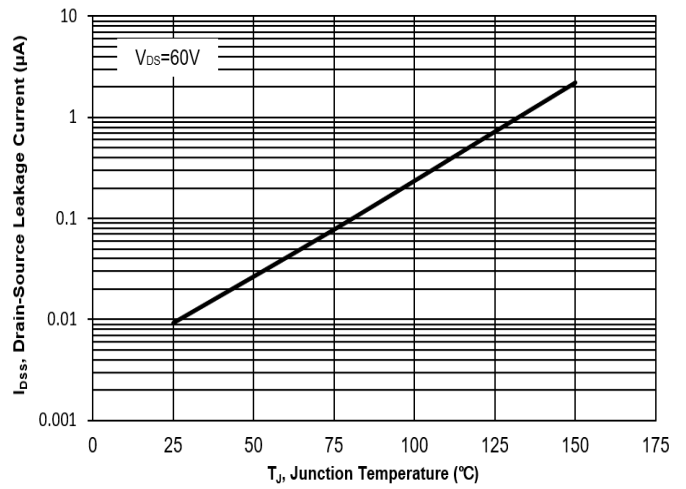

Fig. 9 $V_{(BR)DSS}$ vs. Junction Temperature

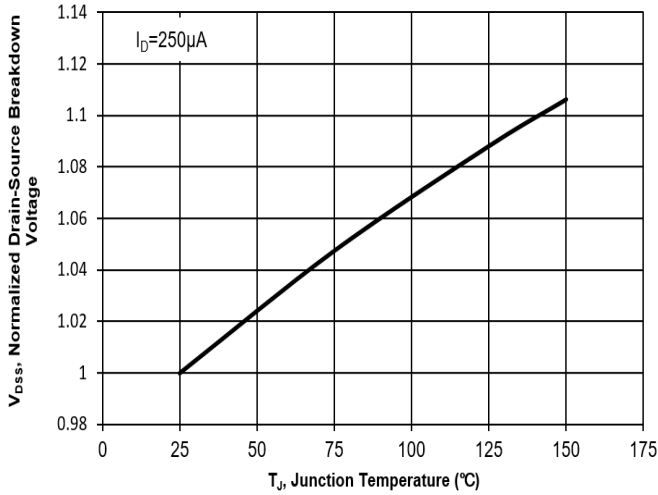

Fig. 10 Gate Threshold Variation vs. T_j

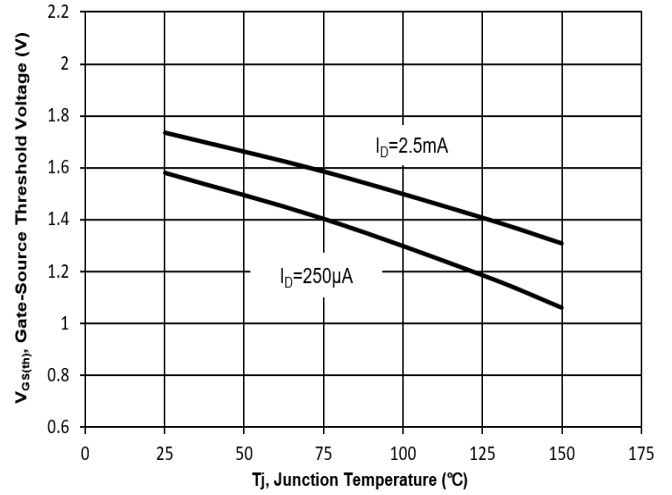
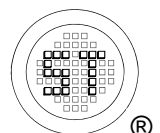
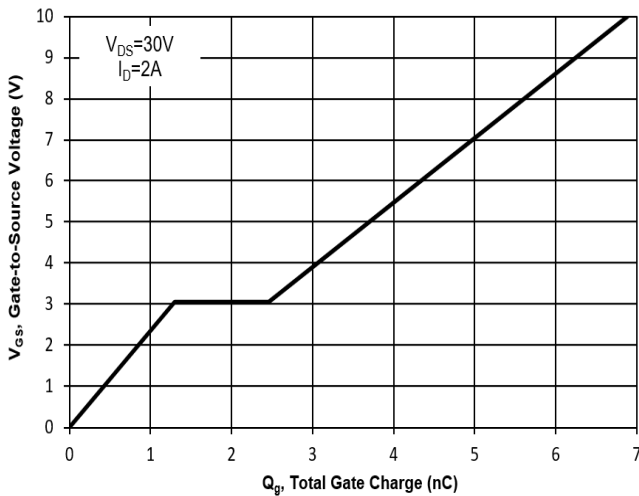

Fig. 11 Gate Charge



Test Circuits

Fig.1-1 Switching times test circuit

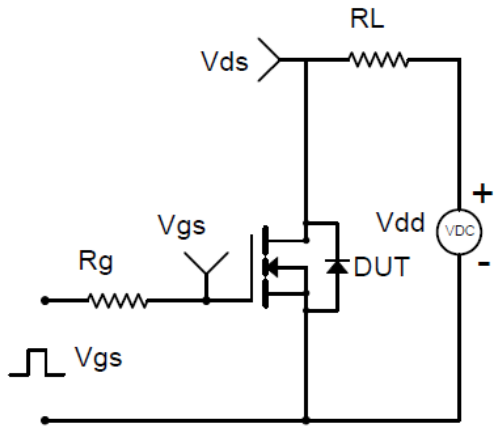

Fig.1-2 Switching Waveform

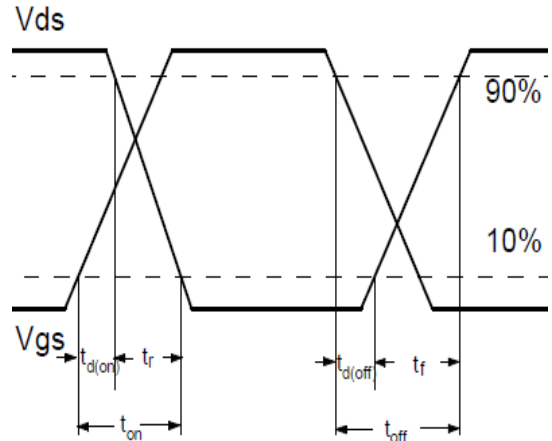

Fig.2-1 Gate charge test circuit

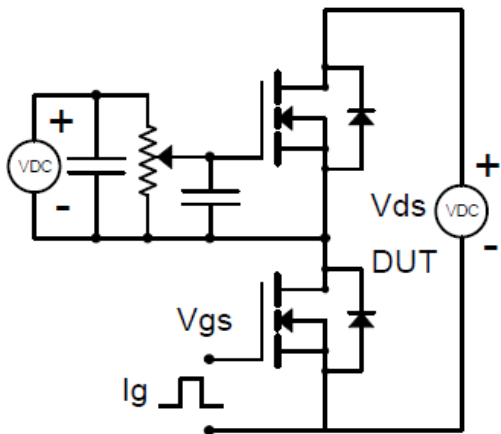
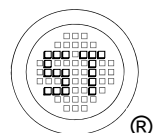
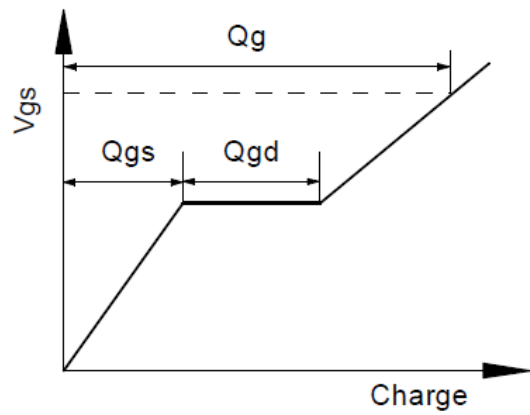

Fig.2-2 Gate charge waveform



MMFTN2308K

Package Outline (Dimensions in mm)

SOT-23

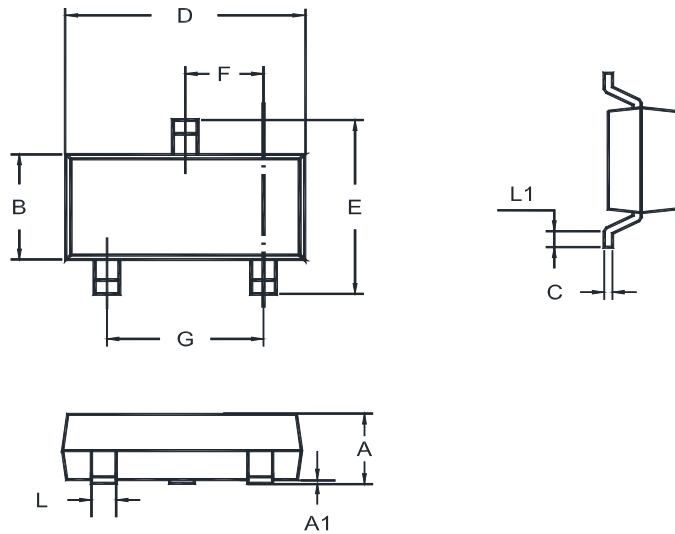

Unit	A	A1	B	C	D	E	F	G	L	L1
mm	1.20	0.100	1.40	0.19	3.04	2.6	1.02	2.04	0.51	0.2
	0.89	0.013	1.20	0.08	2.80	2.2	0.89	1.78	0.37	MIN

Recommended Soldering Footprint

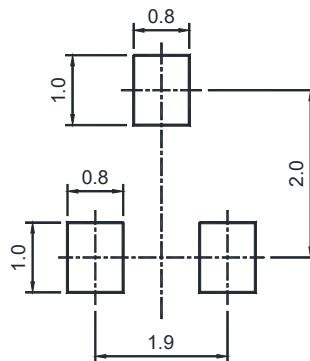

Packing information

Package	Tape Width (mm)	Pitch		Reel Size		Per Reel Packing Quantity
		mm	inch	mm	inch	
SOT-23	8	4 ± 0.1	0.157 ± 0.004	178	7	3,000

Marking information

- " WA " = Part No.
 - " YM " = Date Code Marking
 - " Y " = Year
 - " M " = Month
- Font type: Arial

