

MMFTN2304

N-Channel Enhancement Mode MOSFET

Features

- Surface-mounted package
- Advanced trench cell design

Applications

- Portable appliances
- Battery management
- High speed switch
- Low power DC to DC Converter

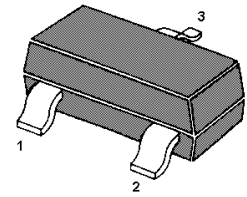
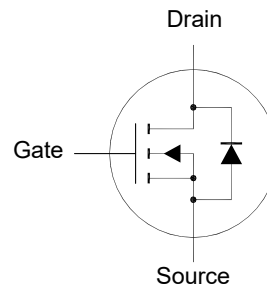

1. Gate 2. Source 3. Drain
SOT-23 Plastic Package

Absolute Maximum Ratings (at $T_a = 25^\circ\text{C}$ unless otherwise specified)

Parameter	Symbol	Value	Unit
Drain-Source Voltage	V_{DS}	30	V
Drain-Gate Voltage	V_{GS}	± 20	V
Drain Current - Continuous	I_D	3.3	A
Drain Current - Pulsed ¹⁾	I_{DM}	15	A
Total Power Dissipation ²⁾	P_{tot}	350	mW
Operating Junction Temperature	T_J	150	$^\circ\text{C}$
Storage Temperature Range	T_{stg}	- 55 to + 150	$^\circ\text{C}$

Thermal Resistance Ratings

Parameter	Symbol	Max.	Unit
Thermal Resistance from Junction to Ambient ²⁾	$R_{\theta JA}$	357	$^\circ\text{C}/\text{W}$

¹⁾ Pulse Test: Pulse Width $\leq 100 \mu\text{s}$, Duty Cycle $\leq 2\%$, Repetitive rating, pulse width limited by junction temperature $T_{J(\text{MAX})} = 150^\circ\text{C}$.

²⁾ Device mounted on FR-4 substrate PC board, 2oz copper, with minimum recommended pad layout.

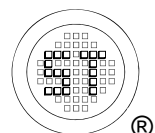

MMFTN2304

Characteristics at $T_a = 25^\circ\text{C}$ unless otherwise specified

Parameter	Symbol	Min.	Typ.	Max.	Unit
STATIC PARAMETERS					
Drain-Source Breakdown Voltage at $I_D = 250 \mu\text{A}$	$V_{(BR)DSS}$	30	-	-	V
Drain-Source Leakage Current at $V_{DS} = 30 \text{ V}$	I_{DSS}	-	-	1	μA
Gate-Source Leakage Current at $V_{GS} = \pm 20 \text{ V}$	I_{GSS}	-	-	± 100	nA
Gate-Source Threshold Voltage at $V_{GS} = V_{DS}$, $I_D = 250 \mu\text{A}$	$V_{GS(th)}$	1	-	2.2	V
Drain-Source On-State Resistance at $V_{GS} = 10 \text{ V}$, $I_D = 3.2 \text{ A}$ at $V_{GS} = 4.5 \text{ V}$, $I_D = 2.8 \text{ A}$	$R_{DS(on)}$	- -	- -	60 75	m Ω
DYNAMIC PARAMETERS					
Forward Transconductance at $V_{DS} = 5 \text{ V}$, $I_D = 3.2 \text{ A}$	g_{fs}	-	6	-	S
Gate Resistance at $V_{DS} = 0 \text{ V}$, $V_{GS} = 0 \text{ V}$, $f = 1 \text{ MHz}$	R_g	-	4.4	-	Ω
Input Capacitance at $V_{GS} = 0 \text{ V}$, $V_{DS} = 15 \text{ V}$, $f = 1 \text{ MHz}$	C_{iss}	-	313	-	pF
Output Capacitance at $V_{GS} = 0 \text{ V}$, $V_{DS} = 15 \text{ V}$, $f = 1 \text{ MHz}$	C_{oss}	-	42	-	pF
Reverse Transfer Capacitance at $V_{GS} = 0 \text{ V}$, $V_{DS} = 15 \text{ V}$, $f = 1 \text{ MHz}$	C_{rss}	-	22	-	pF
Total Gate Charge at $V_{DS} = 15 \text{ V}$, $I_D = 3 \text{ A}$, $V_{GS} = 10 \text{ V}$ at $V_{DS} = 15 \text{ V}$, $I_D = 3 \text{ A}$, $V_{GS} = 4.5 \text{ V}$	Q_g	- -	6.7 3.2	- -	nC
Gate-Source Charge at $V_{DS} = 15 \text{ V}$, $I_D = 3 \text{ A}$, $V_{GS} = 10 \text{ V}$	Q_{gs}	-	1.1	-	nC
Gate-Drain Charge at $V_{DS} = 15 \text{ V}$, $I_D = 3 \text{ A}$, $V_{GS} = 10 \text{ V}$	Q_{gd}	-	1.1	-	nC
Turn-On Delay Time at $V_{DD} = 15 \text{ V}$, $V_{GS} = 10 \text{ V}$, $I_D = 3 \text{ A}$, $R_g = 3.9 \Omega$	$t_{d(on)}$	-	5.8	-	nS
Turn-On Rise Time at $V_{DD} = 15 \text{ V}$, $V_{GS} = 10 \text{ V}$, $I_D = 3 \text{ A}$, $R_g = 3.9 \Omega$	t_r	-	13	-	nS
Turn-Off Delay Time at $V_{DD} = 15 \text{ V}$, $V_{GS} = 10 \text{ V}$, $I_D = 3 \text{ A}$, $R_g = 3.9 \Omega$	$t_{d(off)}$	-	8.4	-	nS
Turn-Off Fall Time at $V_{DD} = 15 \text{ V}$, $V_{GS} = 10 \text{ V}$, $I_D = 3 \text{ A}$, $R_g = 3.9 \Omega$	t_f	-	2.4	-	nS
Body-Diode PARAMETERS					
Drain-Source Diode Forward Voltage at $I_s = 3 \text{ A}$, $V_{GS} = 0 \text{ V}$	V_{SD}	-	-	1.2	V
Body-Diode Continuous Current	I_s	-	-	3.3	A
Body Diode Reverse Recovery Time at $I_s = 3 \text{ A}$, $di/dt = 100 \text{ A} / \mu\text{s}$	t_{rr}	-	5.4	-	nS
Body Diode Reverse Recovery Charge at $I_s = 3 \text{ A}$, $di/dt = 100 \text{ A} / \mu\text{s}$	Q_{rr}	-	1.7	-	nC

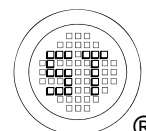

Electrical Characteristics Curves

Fig. 1 Typical Output Characteristics

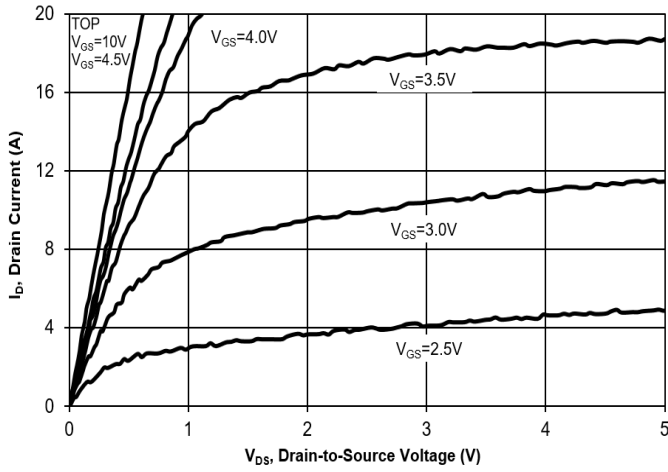

Fig. 2 Typical Transfer Characteristics

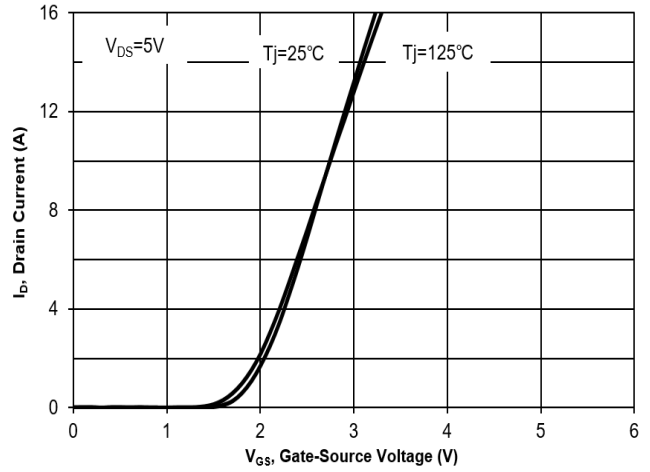

Fig. 3 on-Resistance vs. Drain Current

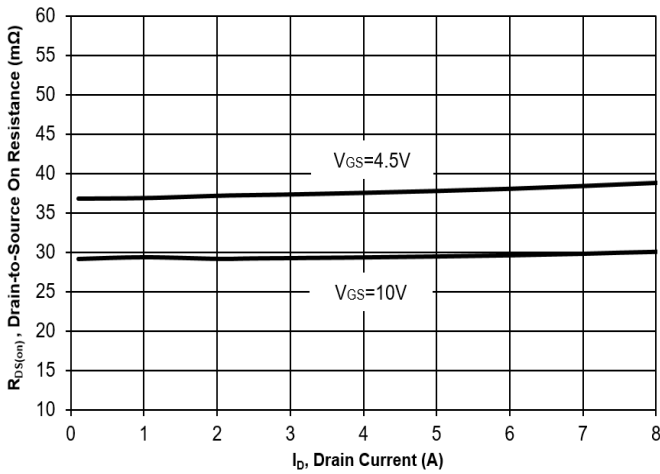

Fig. 4 on-Resistance vs. Gate-Source Voltage

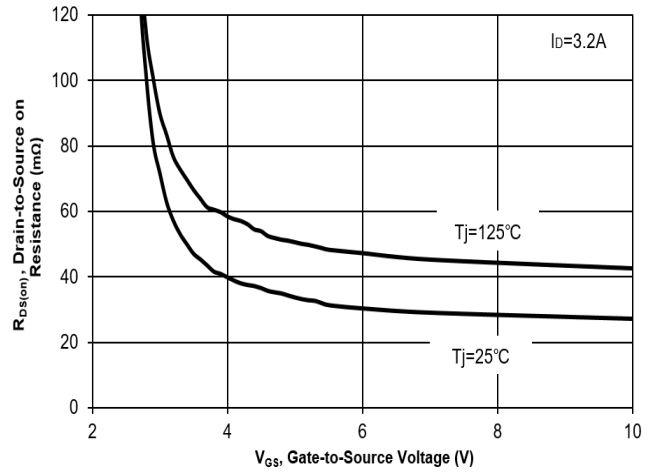

Fig. 5 on-Resistance vs. T_J

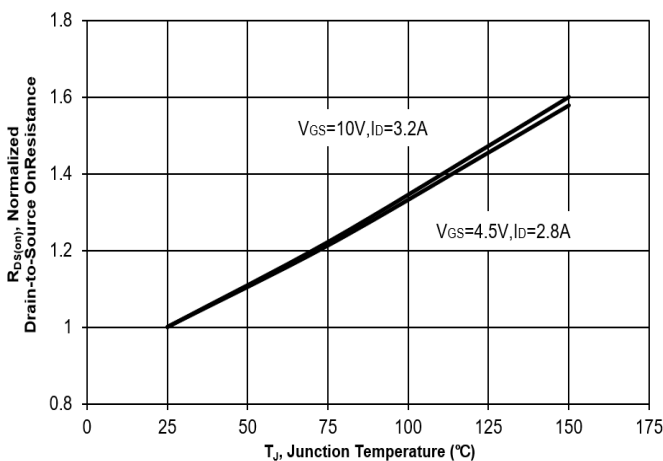
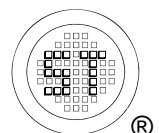
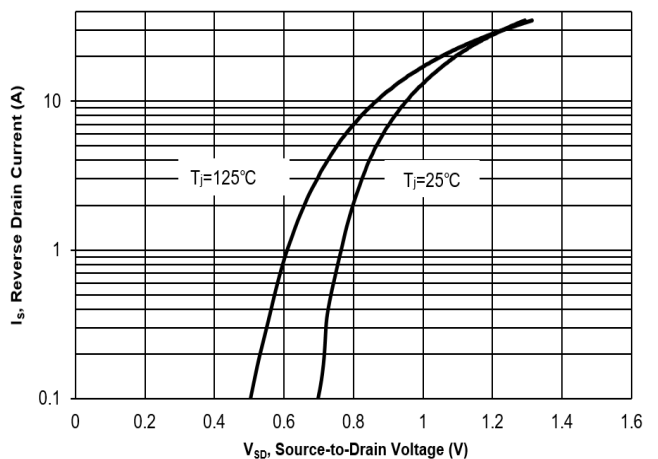

Fig. 6 Body Diodes Forward Characteristics



Electrical Characteristics Curves

Fig. 7 Typical Junction Capacitance

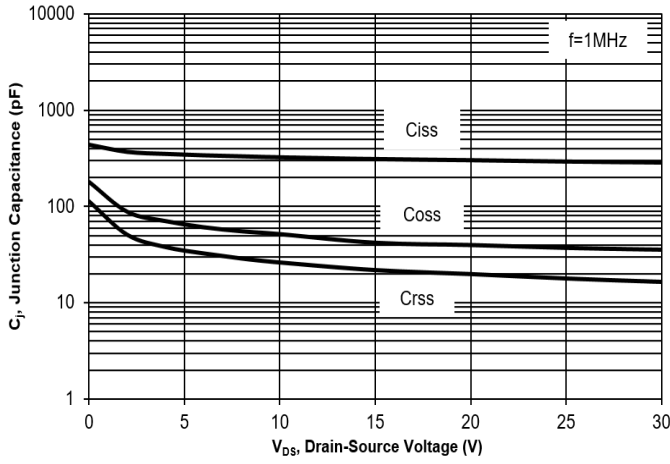

Fig. 8 Drain-Source Leakage Current vs. T_j

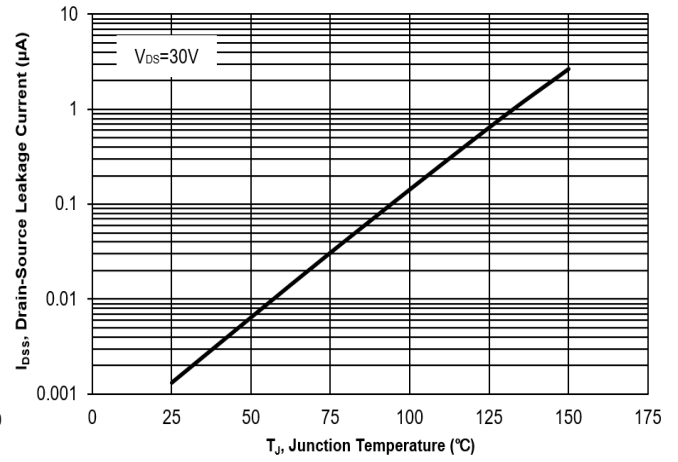

Fig. 9 $V_{(BR)DSS}$ vs. Junction Temperature

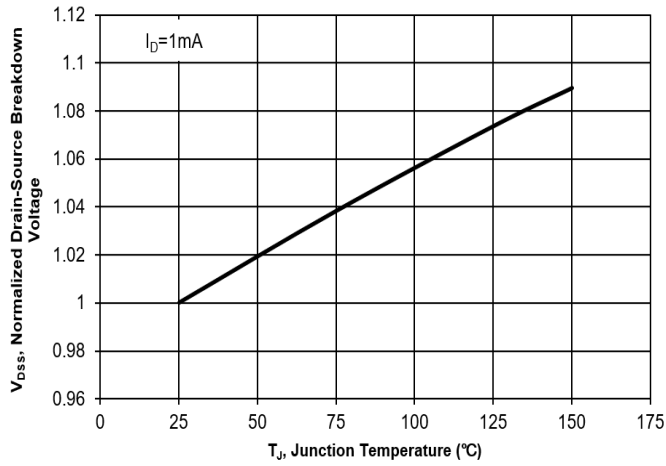
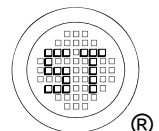
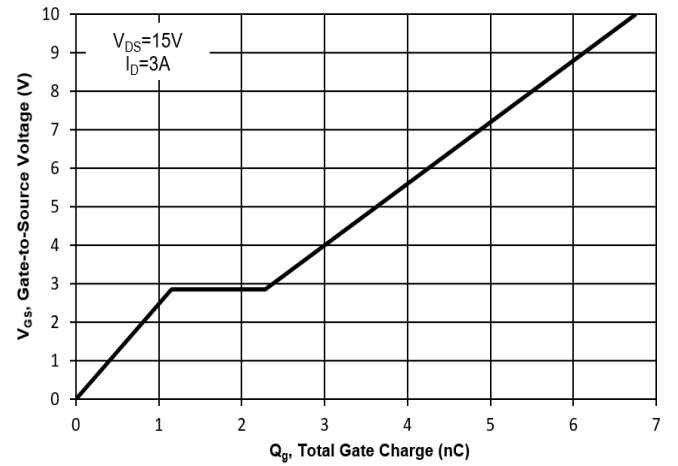

Fig. 10 Gate Charge



Test Circuits

Fig.1-1 Switching times test circuit

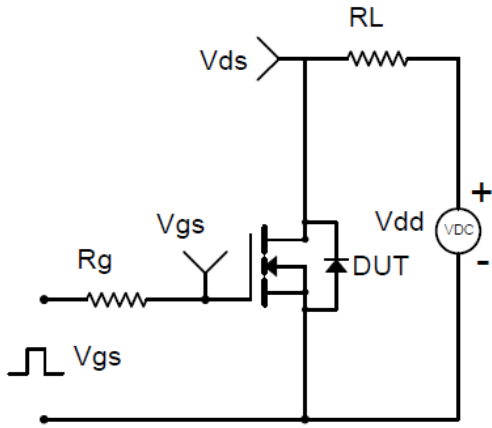

Fig.1-2 Switching Waveform

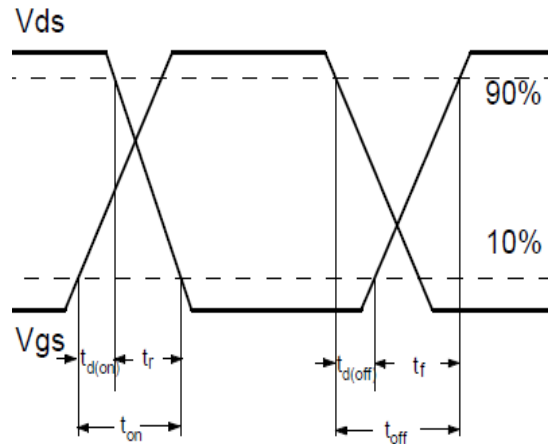

Fig.2-1 Gate charge test circuit

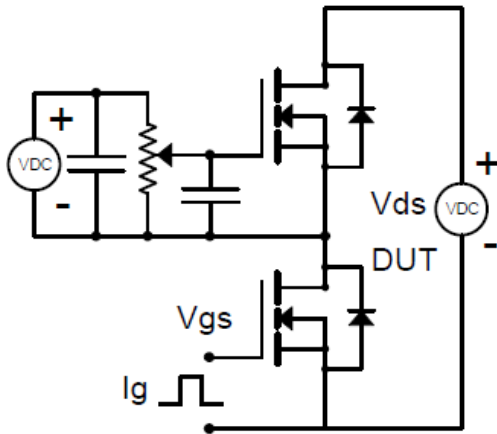
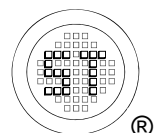
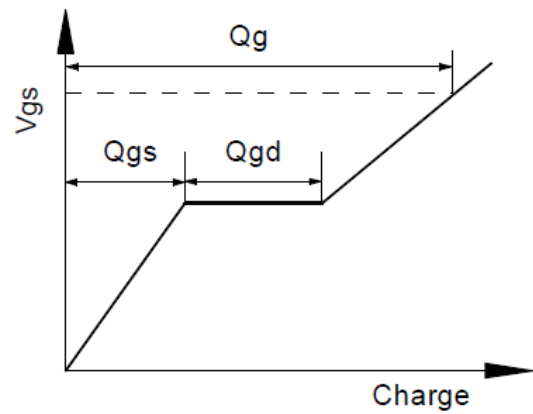

Fig.2-2 Gate charge waveform



MMFTN2304

Package Outline (Dimensions in mm)

SOT-23

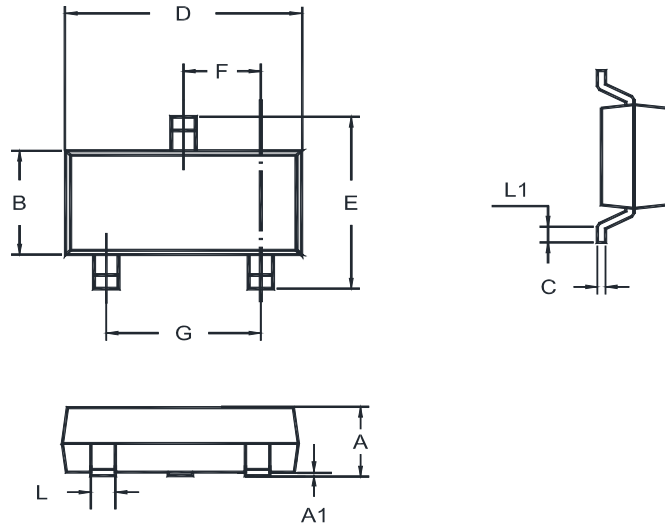

Unit	A	A1	B	C	D	E	F	G	L	L1
mm	1.20	0.100	1.40	0.19	3.04	2.6	1.02	2.04	0.51	0.2
	0.89	0.013	1.20	0.08	2.80	2.2	0.89	1.78	0.37	MIN

Recommended Soldering Footprint

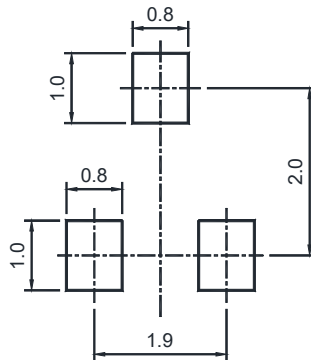

Packing information

Package	Tape Width (mm)	Pitch		Reel Size		Per Reel Packing Quantity
		mm	inch	mm	inch	
SOT-23	8	4 ± 0.1	0.157 ± 0.004	178	7	3,000

Marking information

- " VF " = Part No.
 - " YM " = Date Code Marking
 - " Y " = Year
 - " M " = Month
- Font type: Arial

