

MMDTX144DW

Complementary NPN/PNP Silicon Epitaxial Planar Digital Transistor

For switching and interface circuit and drivecircuit applications

Features

- Transistors with different polarity and built-in bias resistors R1 and R2
- Simplification of circuit design
- Reduces number of components and board space

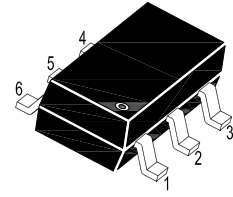
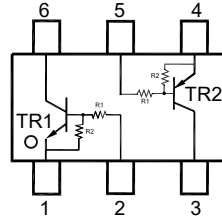

1. Emitter 2. Base 3. Collector
4. Emitter 5. Base 6. Collector
SOT-363 Plastic Package

Absolute Maximum Ratings at $T_a = 25^\circ\text{C}$ (TR1)

Parameter	Symbol	Value	Unit
Collector Base Voltage	V_{CBO}	50	V
Collector Emitter Voltage	V_{CEO}	50	V
Emitter Base Voltage	V_{EBO}	6	V
Collector Current	I_c	100	mA

Absolute Maximum Ratings at $T_a = 25^\circ\text{C}$ (TR2)

Parameter	Symbol	Value	Unit
Collector Base Voltage	$-V_{CBO}$	50	V
Collector Emitter Voltage	$-V_{CEO}$	50	V
Emitter Base Voltage	$-V_{EBO}$	6	V
Collector Current	$-I_c$	100	mA

Absolute Maximum Ratings at $T_a = 25^\circ\text{C}$ (TR1 and TR2)

Parameter	Symbol	Value	Unit
Total Power Dissipation	P_{tot}	200	mW
Junction Temperature	T_j	150	$^\circ\text{C}$
Storage Temperature Range	T_{stg}	- 55 to + 150	$^\circ\text{C}$
Thermal Resistance from Junction to Ambient ¹⁾	$R_{\theta JA}$	625	$^\circ\text{C/W}$

¹⁾ Device mounted on FR-4 substrate PC board, with minimum recommended pad layout.

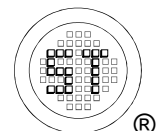

MMDTX144DW

Characteristics at $T_a = 25^\circ\text{C}$ (TR1:NPN)

Parameter	Symbol	Min.	Typ.	Max.	Unit
DC Current Gain at $V_{CE} = 5\text{ V}$, $I_C = 10\text{ mA}$	h_{FE}	80	-	-	-
Collector Base Cutoff Current at $V_{CB} = 50\text{ V}$	I_{CBO}	-	-	100	nA
Collector Emitter Cutoff Current at $V_{CE} = 50\text{ V}$	I_{CEO}	-	-	500	nA
Emitter Base Cutoff Current at $V_{EB} = 6\text{ V}$	I_{EBO}	-	-	0.15	mA
Collector Emitter Saturation Voltage at $I_C = 5\text{ mA}$, $I_B = 0.25\text{ mA}$	V_{CEsat}	-	-	0.3	V
Input Voltage (OFF) at $V_{CE} = 5\text{ V}$, $I_C = 100\text{ }\mu\text{A}$	$V_{I(OFF)}$	0.5	-	1	V
Input Voltage (ON) at $V_{CE} = 0.2\text{ V}$, $I_C = 5\text{ mA}$	$V_{I(ON)}$	0.7	-	1.8	V
Gain Bandwidth Product at $V_{CE} = 10\text{ V}$, $I_C = 5\text{ mA}$, $f = 100\text{ MHz}$	f_T	-	250	-	MHz

Characteristics at $T_a = 25^\circ\text{C}$ (TR2:PNP)

Parameter	Symbol	Min.	Typ.	Max.	Unit
DC Current Gain at $-V_{CE} = 5\text{ V}$, $-I_C = 10\text{ mA}$	h_{FE}	80	-	-	-
Collector Base Cutoff Current at $-V_{CB} = 50\text{ V}$	$-I_{CBO}$	-	-	100	nA
Collector Emitter Cutoff Current at $-V_{CE} = 50\text{ V}$	$-I_{CEO}$	-	-	500	nA
Emitter Base Cutoff Current at $-V_{EB} = 6\text{ V}$	$-I_{EBO}$	-	-	0.15	mA
Collector Emitter Saturation Voltage at $-I_C = 5\text{ mA}$, $-I_B = 0.25\text{ mA}$	$-V_{CEsat}$	-	-	0.3	V
Input Voltage (OFF) at $-V_{CE} = 5\text{ V}$, $-I_C = 100\text{ }\mu\text{A}$	$-V_{I(OFF)}$	0.5	-	1	V
Input Voltage (ON) at $-V_{CE} = 0.2\text{ V}$, $-I_C = 5\text{ mA}$	$-V_{I(ON)}$	0.7	-	1.8	V
Gain Bandwidth Product at $-V_{CE} = 10\text{ V}$, $-I_C = 5\text{ mA}$, $f = 100\text{ MHz}$	f_T	-	200	-	MHz

Characteristics at $T_a = 25^\circ\text{C}$ (TR1 and TR2)

Input Resistance	R_1	7	10	13	K Ω
Resistance Ratio	R_1/R_2	0.191	0.213	0.232	-

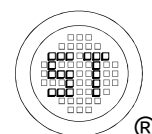

Electrical Characteristics Curves:TR1

Fig 1. $V_{I(ON)}$ vs. Collector Current

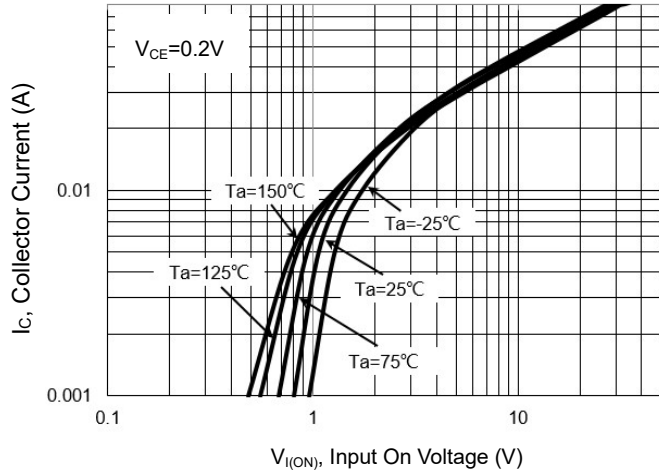

Fig 2. $V_{I(off)}$ vs. Collector Current

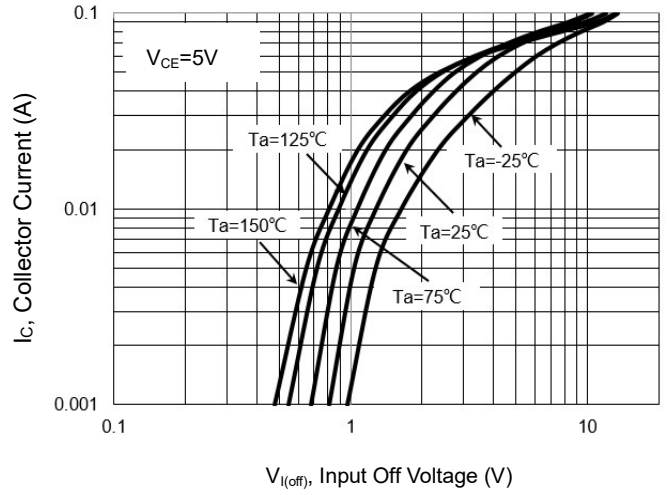

Fig 3. DC Current Gain vs. Collector Current

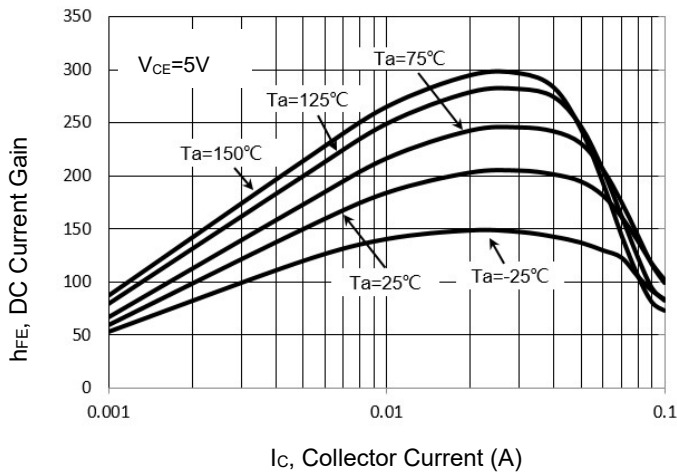
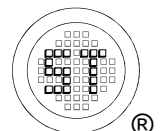
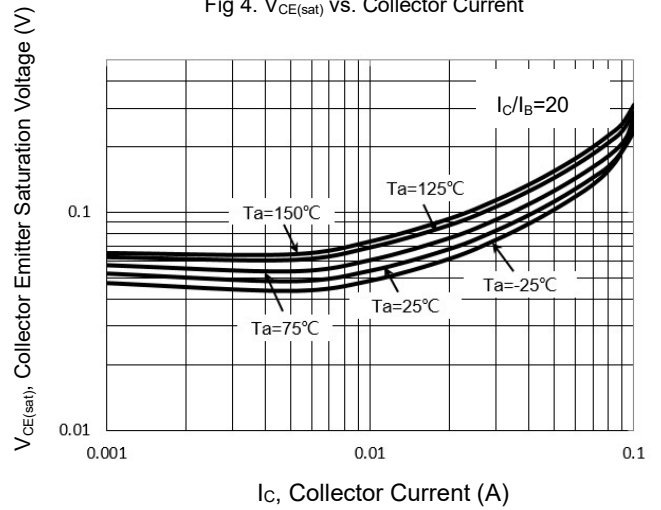

Fig 4. $V_{CE(sat)}$ vs. Collector Current



MMDTX144DW

Electrical Characteristics Curves:TR2

Fig 1. $V_{I(ON)}$ vs. Collector Current

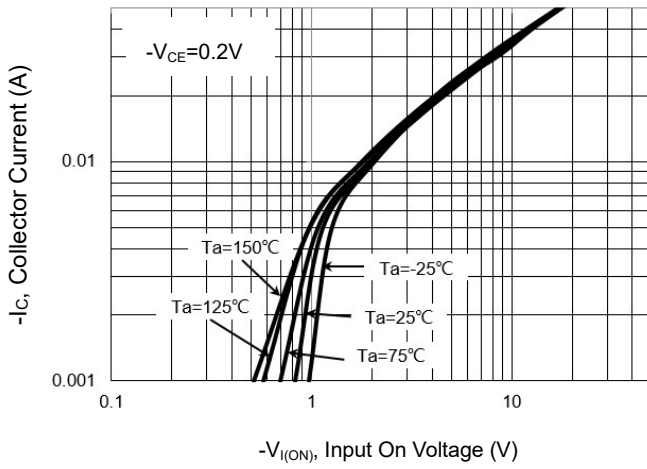

Fig 2. $V_{I(off)}$ vs. Collector Current

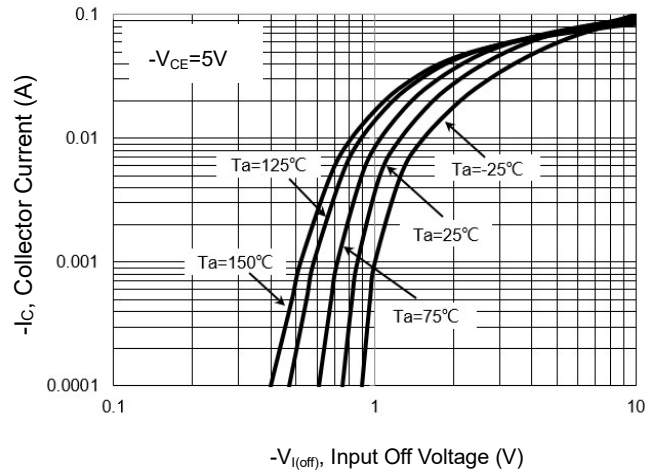

Fig 3. DC Current Gain vs. Collector Current

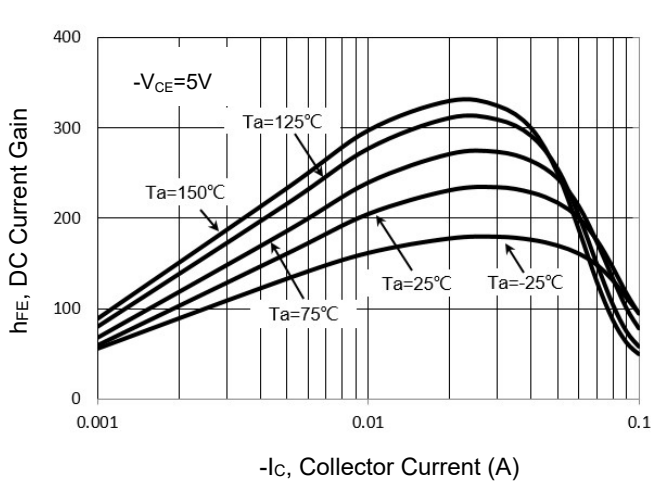
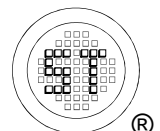
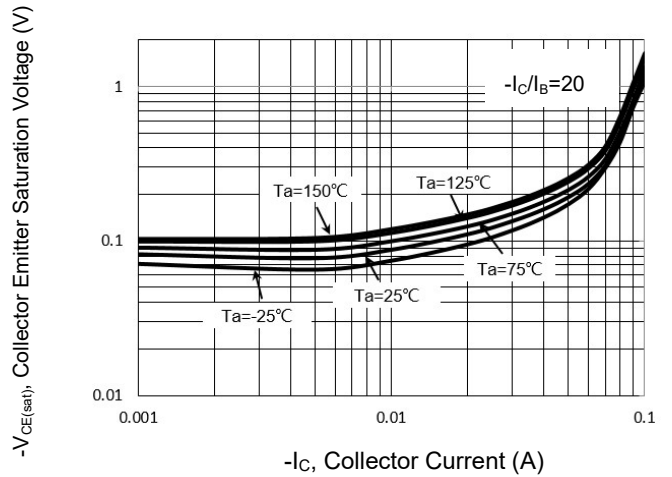

Fig 4. $V_{CE(sat)}$ vs. Collector Current



MMDTX144DW

Package Outline Dimensions (Units: mm)

SOT-363

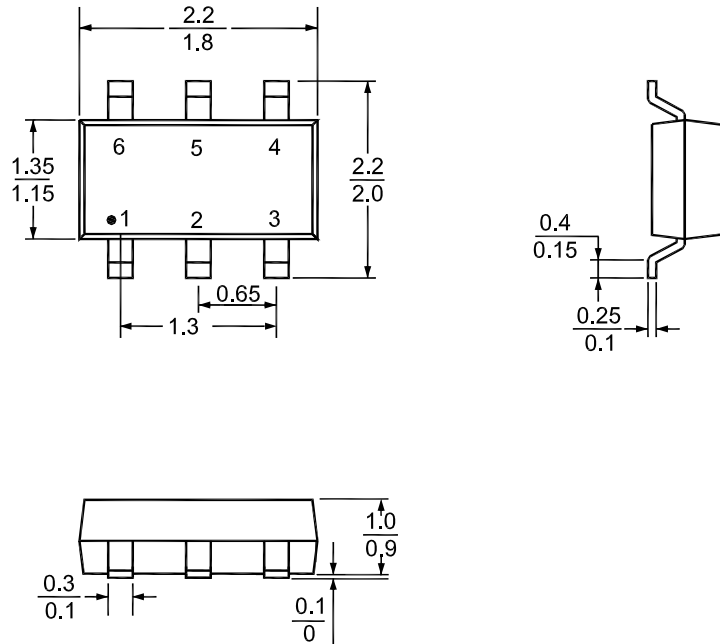

Recommended Soldering Footprint

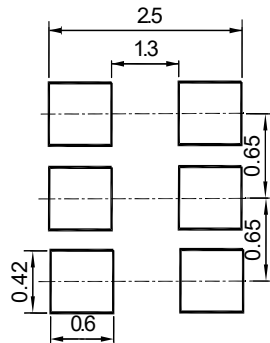

Packing information

Package	Tape Width (mm)	Pitch		Reel Size		Per Reel Packing Quantity
		mm	inch	mm	inch	
SOT-363	8	4 ± 0.1	0.157 ± 0.004	178	7	3,000

Marking information

- "6H" = Part No.
- "YM" = Date Code Marking
- "Y" = Year
- "M" = Month
- Font type: Arial

