

MMDTX141DW-AH

Complementary NPN / PNP Silicon Epitaxial Planar Digital Transistor

for switching and interface circuit and drivecircuit applications

Features

- AEC-Q101 Qualified
- Transistors with different polarity and built-in bias resistors
- Simplification of circuit design
- Reduces number of components and board space
- Halogen and Antimony Free(HAF), RoHS compliant

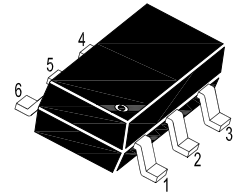
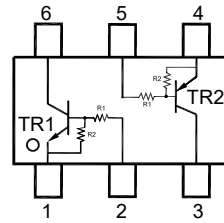

TR1: 1.Emitter 2.Base 6.Collector
TR2: 4.Emitter 5.Base 3.Collector
SOT-363 Plastic package

Resistor Values

R1 (KΩ)	R2 (KΩ)
10	10

Absolute Maximum Ratings at $T_a = 25^\circ\text{C}$ (TR1)

Parameter	Symbol	Value	Unit
Collector Base Voltage	V_{CB0}	50	V
Collector Emitter Voltage	V_{CE0}	50	V
Emitter Base Voltage	V_{EB0}	10	V
Collector Current	I_c	100	mA

Absolute Maximum Ratings at $T_a = 25^\circ\text{C}$ (TR2)

Parameter	Symbol	Value	Unit
Collector Base Voltage	$-V_{CB0}$	50	V
Collector Emitter Voltage	$-V_{CE0}$	50	V
Emitter Base Voltage	$-V_{EB0}$	10	V
Collector Current	$-I_c$	100	mA

Absolute Maximum Ratings at $T_a = 25^\circ\text{C}$ (TR1 and TR2)

Parameter	Symbol	Value	Unit
Total Power Dissipation	P_{tot}	200	mW
Thermal Resistance from Junction to Ambient ¹⁾	$R_{\theta JA}$	625	$^\circ\text{C/W}$
Junction Temperature	T_j	150	$^\circ\text{C}$
Storage Temperature Range	T_{stg}	- 55 to + 150	$^\circ\text{C}$

¹⁾ Device mounted on FR-4 substrate PC board, 2oz copper, with minimum recommended pad layout.

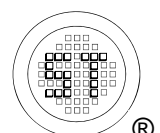

MMDTX141DW-AH

Characteristics at $T_a = 25^\circ\text{C}$ (TR1:NPN)

Parameter	Symbol	Min.	Typ.	Max.	Unit
DC Current Gain at $V_{CE} = 5\text{ V}$, $I_C = 10\text{ mA}$	h_{FE}	50	-	-	-
Collector Base Cutoff Current at $V_{CB} = 50\text{ V}$	I_{CBO}	-	-	100	nA
Collector Emitter Cutoff Current at $V_{CE} = 50\text{ V}$	I_{CEO}	-	-	500	nA
Emitter Base Cutoff Current at $V_{EB} = 10\text{ V}$	I_{EBO}	0.38	-	0.71	mA
Collector Emitter Saturation Voltage at $I_C = 5\text{ mA}$, $I_B = 0.25\text{ mA}$	V_{CEsat}	-	-	0.3	V
Input Voltage (OFF) at $V_{CE} = 5\text{ V}$, $I_C = 100\text{ }\mu\text{A}$	$V_{I(OFF)}$	1	-	1.5	V
Input Voltage (ON) at $V_{CE} = 0.2\text{ V}$, $I_C = 5\text{ mA}$	$V_{I(ON)}$	1.2	-	2.4	V
Gain Bandwidth Product at $V_{CE} = 10\text{ V}$, $I_C = 5\text{ mA}$, $f = 100\text{ MHz}$	f_T	-	250	-	MHz

Characteristics at $T_a = 25^\circ\text{C}$ (TR2:PNP)

Parameter	Symbol	Min.	Typ.	Max.	Unit
DC Current Gain at $-V_{CE} = 5\text{ V}$, $-I_C = 10\text{ mA}$	h_{FE}	50	-	-	-
Collector Base Cutoff Current at $-V_{CB} = 50\text{ V}$	$-I_{CBO}$	-	-	100	nA
Collector Emitter Cutoff Current at $-V_{CE} = 50\text{ V}$	$-I_{CEO}$	-	-	500	nA
Emitter Base Cutoff Current at $-V_{EB} = 10\text{ V}$	$-I_{EBO}$	0.38	-	0.71	mA
Collector Emitter Saturation Voltage at $-I_C = 5\text{ mA}$, $-I_B = 0.25\text{ mA}$	$-V_{CEsat}$	-	-	0.3	V
Input Voltage (OFF) at $-V_{CE} = 5\text{ V}$, $-I_C = 100\text{ }\mu\text{A}$	$-V_{I(OFF)}$	1	-	1.5	V
Input Voltage (ON) at $-V_{CE} = 0.2\text{ V}$, $-I_C = 5\text{ mA}$	$-V_{I(ON)}$	1.2	-	2.4	V
Gain Bandwidth Product at $-V_{CE} = 10\text{ V}$, $-I_C = 5\text{ mA}$, $f = 100\text{ MHz}$	f_T	-	200	-	MHz

Characteristics at $T_a = 25^\circ\text{C}$ (TR1 and TR2)

Input Resistance	R_1	7	10	13	$\text{K}\Omega$
Resistance Ratio	R_1/R_2	0.9	1	1.1	-

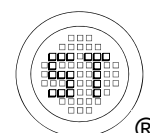

MMDTX141DW-AH

Electrical Characteristics Curves(TR1)

Fig. 1 Output Characteristics Curve

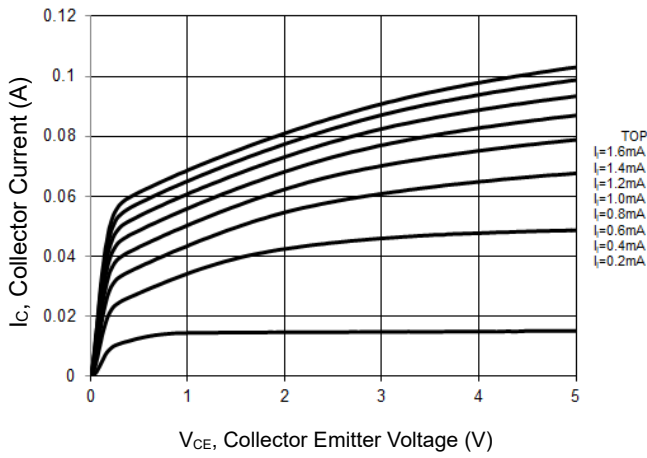

Fig. 2 Collector Current vs. Input on Voltage

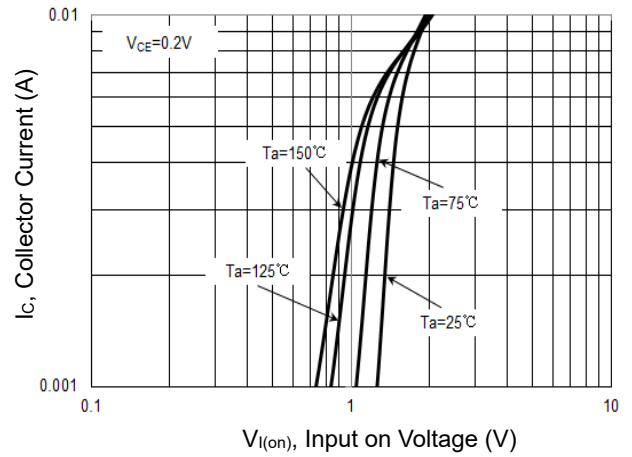

Fig. 3 Collector Current vs. Input off Voltage

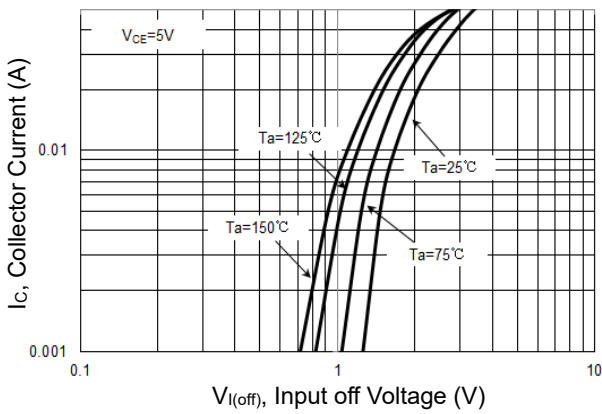

Fig. 4 DC Current Gain vs. Collector Current

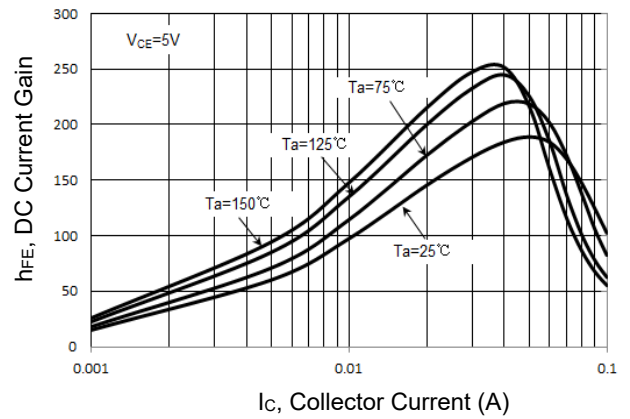
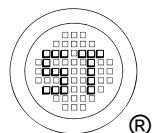
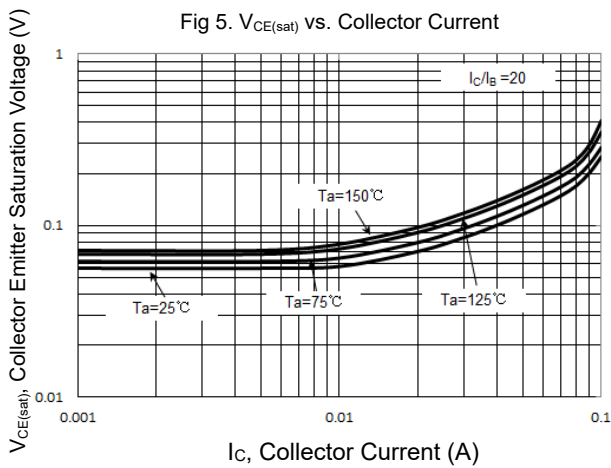

Fig 5. $V_{CE(sat)}$ vs. Collector Current



MMDTX141DW-AH

Electrical Characteristics Curves(TR2)

Fig. 1 Output Characteristics Curve

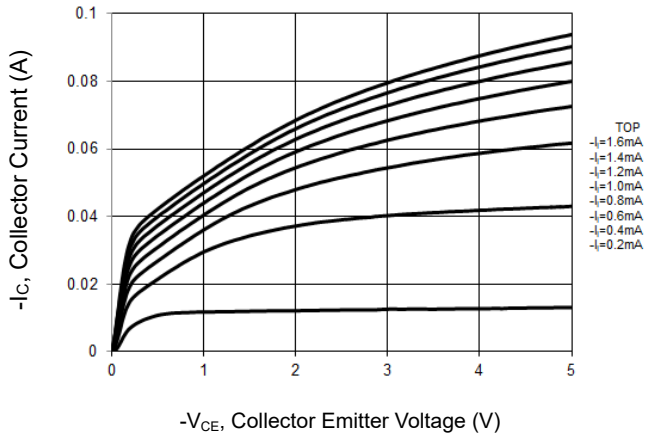

Fig. 2 Collector Current vs. Input on Voltage

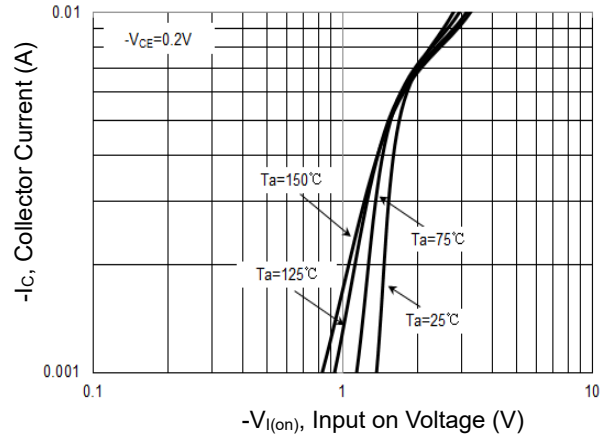

Fig. 3 Collector Current vs. Input off Voltage

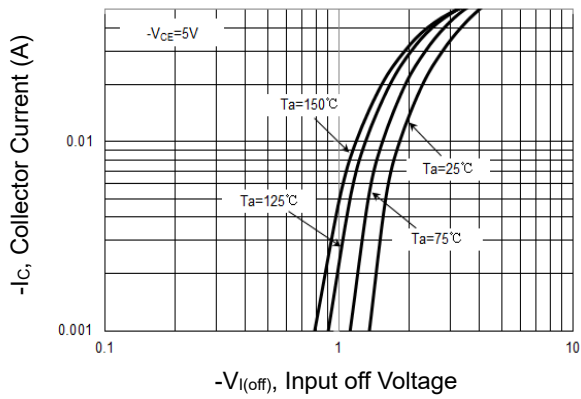

Fig. 4 DC Current Gain vs. Collector Current

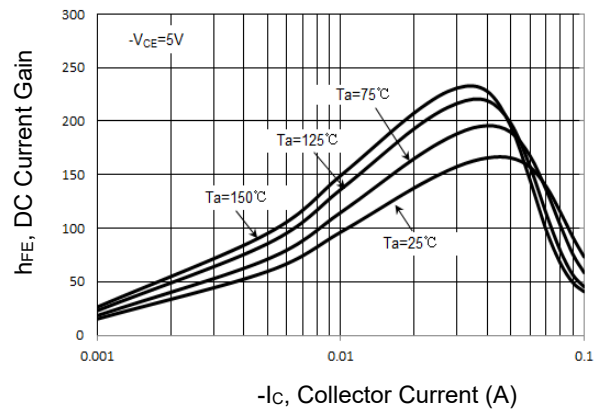
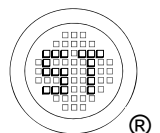
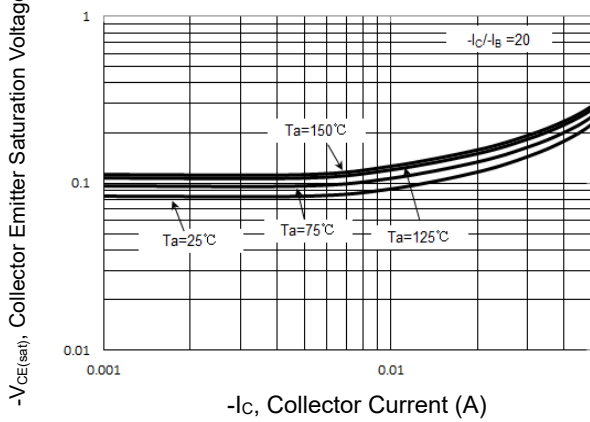

Fig 5. $V_{CE(sat)}$ vs. Collector Current



MMDTX141DW-AH

Package Outline Dimensions (Units: mm)

SOT-363

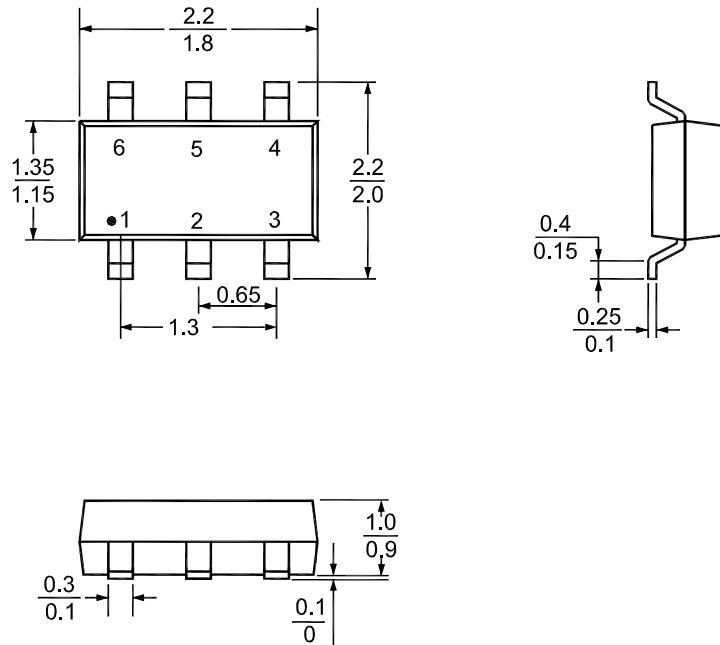

Recommended Soldering Footprint

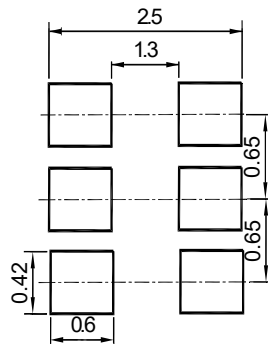

Packing information

Package	Tape Width (mm)	Pitch		Reel Size		Per Reel Packing Quantity
		mm	inch	mm	inch	
SOT-363	8	4 ± 0.1	0.157 ± 0.004	178	7	3,000

Marking information

"•" = HAF (Halogen and Antimony Free(HAF)).

"6B" = Part No.

"YM" = Date Code Marking

"Y" = Year

"M" = Month

Font type: Arial

