

MMDT1901DW...MMDT1909DW

Dual NPN Silicon Epitaxial Planar Digital Transistor

For switching and interface circuit and drive circuit applications

Features

- Transistors with built-in bias resistors R1 and R2
- Simplification of circuit design
- Reduces number of components and board space

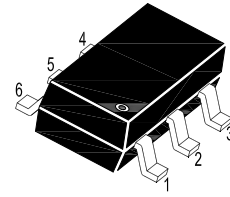
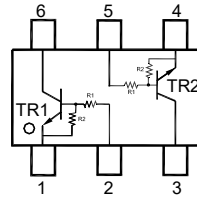

TR1: 1. Emitter 2. Base 6. Collector
TR2: 4. Emitter 5. Base 3. Collector
SOT-363 Plastic Package

Resistor Values

Type	R1 (K Ω)	R2 (K Ω)
MMDT1901DW	4.7	4.7
MMDT1902DW	10	10
MMDT1903DW	22	22
MMDT1904DW	47	47
MMDT1905DW	2.2	47
MMDT1906DW	4.7	47
MMDT1907DW	10	47
MMDT1908DW	22	47
MMDT1909DW	47	22

Absolute Maximum Ratings at T_a = 25°C

Parameter	Symbol	Value	Unit
Collector Base Voltage	V _{CBO}	50	V
Collector Emitter Voltage	V _{CEO}	50	V
Emitter Base Voltage	V _{EBO}	10 5 6 7 15	V
Collector Current	I _C	100	mA
Total Power Dissipation	P _{tot}	200	mW
Junction Temperature	T _j	150	°C
Storage Temperature Range	T _{stg}	- 55 to + 150	°C

Thermal Characteristics

Parameter	Symbol	Max.	Unit
Thermal Resistance from Junction to Ambient ¹⁾	R _{θJA}	625	°C/W

¹⁾ Device mounted on FR-4 substrate PC board, with minimum recommended pad layout.

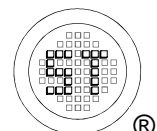

MMDT1901DW...MMDT1909DW

Characteristics at $T_a = 25^\circ\text{C}$

Parameter	Symbol	Min.	Typ.	Max.	Unit	
DC Current Gain at $V_{CE} = 5\text{ V}$, $I_C = 10\text{ mA}$	MMDT1901DW MMDT1902DW MMDT1903DW MMDT1904DW MMDT1905DW MMDT1906DW MMDT1907DW MMDT1908DW MMDT1909DW	h_{FE} h_{FE} h_{FE} h_{FE} h_{FE} h_{FE} h_{FE} h_{FE} h_{FE}	30 50 70 80 80 80 80 80 80	- - - - - - - - -	- - - - - - - - -	- - - - - - - - -
Collector Base Cutoff Current at $V_{CB} = 50\text{ V}$		I_{CBO}	-	-	100	nA
Collector Emitter Cutoff Current at $V_{CE} = 50\text{ V}$		I_{CEO}	-	-	0.5	μA
Emitter Base Cutoff Current at $V_{EB} = 10\text{ V}$ at $V_{EB} = 10\text{ V}$ at $V_{EB} = 10\text{ V}$ at $V_{EB} = 10\text{ V}$ at $V_{EB} = 5\text{ V}$ at $V_{EB} = 5\text{ V}$ at $V_{EB} = 6\text{ V}$ at $V_{EB} = 7\text{ V}$ at $V_{EB} = 15\text{ V}$	MMDT1901DW MMDT1902DW MMDT1903DW MMDT1904DW MMDT1905DW MMDT1906DW MMDT1907DW MMDT1908DW MMDT1909DW	I_{EBO}	820 380 170 82 78 74 81 78 167	- - - - - - - - -	1520 710 330 150 145 138 150 145 311	μA
Collector Emitter Saturation Voltage at $I_C = 5\text{ mA}$, $I_B = 0.25\text{ mA}$		$V_{CE(sat)}$	-	-	0.3	V
Input Voltage (ON) at $V_{CE} = 0.2\text{ V}$, $I_C = 5\text{ mA}$	MMDT1901DW MMDT1902DW MMDT1903DW MMDT1904DW MMDT1905DW MMDT1906DW MMDT1907DW MMDT1908DW MMDT1909DW	$V_{I(ON)}$	1.1 1.2 1.3 1.5 0.6 0.7 0.7 1 2.2	- - - - - - - - -	2 2.4 3 5 1.1 1.3 1.8 2.6 5.8	V
Input Voltage (OFF) at $V_{CE} = 5\text{ V}$, $I_C = 100\text{ }\mu\text{A}$	MMDT1901DW~1904DW MMDT1905DW~1906DW MMDT1907DW MMDT1908DW MMDT1909DW	$V_{I(OFF)}$	1 0.5 0.5 0.6 1.5	- - - - -	1.5 0.8 1 1.16 2.6	V
Transition Frequency at $V_{CE} = 10\text{ V}$, $I_C = 5\text{ mA}$		f_T	-	250	-	MHz

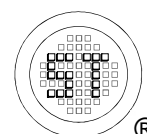

MMDT1901DW...MMDT1909DW

Characteristics at $T_a = 25^\circ\text{C}$

Input Resistance	MMDT1901DW	R_1	3.29	4.7	6.11	K Ω
	MMDT1902DW		7	10	13	
	MMDT1903DW		15.4	22	28.6	
	MMDT1904DW		32.9	47	61.1	
	MMDT1905DW		1.54	2.2	2.86	
	MMDT1906DW		3.29	4.7	6.11	
	MMDT1907DW		7	10	13	
	MMDT1908DW		15.4	22	28.6	
	MMDT1909DW		32.9	47	61.1	
Resistance Ratio	MMDT1901DW~1904DW	R_1/R_2	0.9	1	1.1	-
	MMDT1905DW		0.0421	0.0468	0.0515	
	MMDT1906DW		0.09	0.1	0.11	
	MMDT1907DW		0.191	0.213	0.232	
	MMDT1908DW		0.421	0.468	0.515	
	MMDT1909DW		1.92	2.14	2.35	

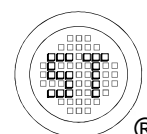

Electrical Characteristics Curves (MMDT1902DW)

Fig 1. Collector Current vs. $V_{I(ON)}$

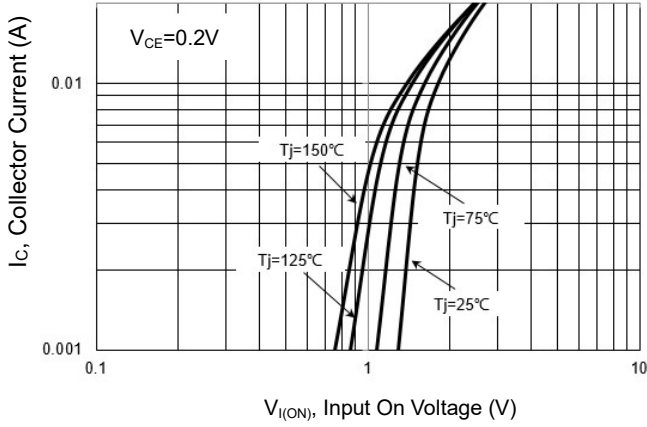

Fig 2. Collector Current vs. $V_{I(off)}$

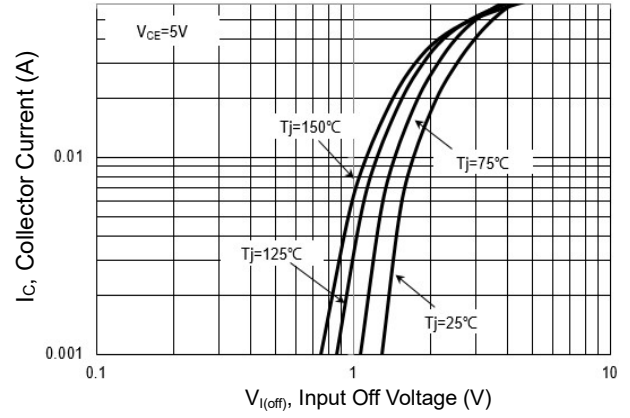

Fig 3. DC Current Gain vs. Collector Current

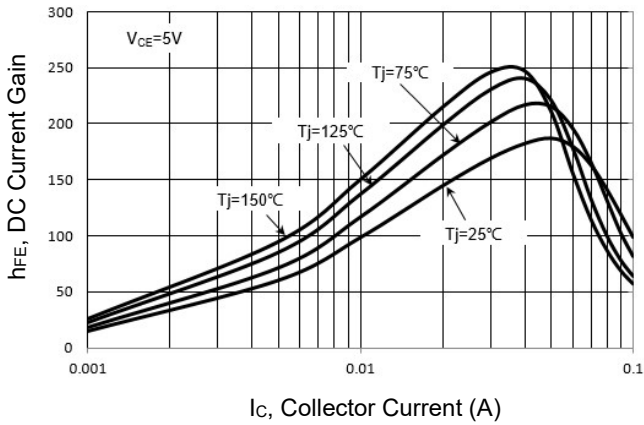
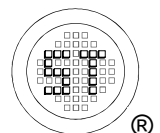
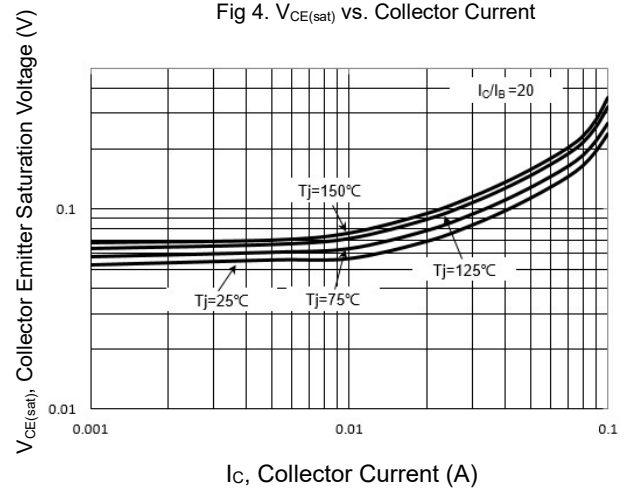

Fig 4. $V_{CE(sat)}$ vs. Collector Current



Electrical Characteristics Curves (MMDT1904DW)

Fig 1. Collector Current vs. $V_{I(ON)}$

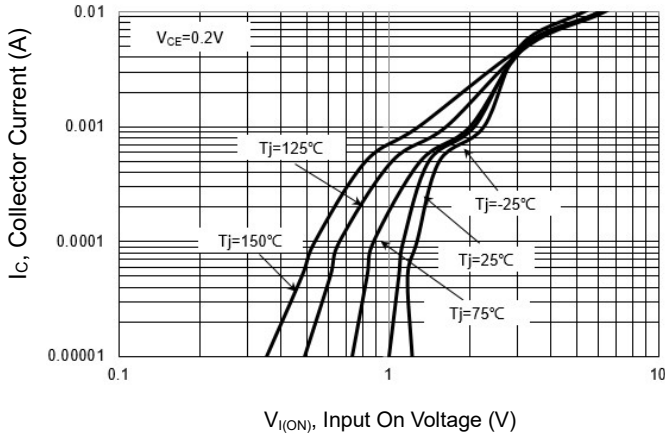

Fig 2. Collector Current vs. $V_{I(off)}$

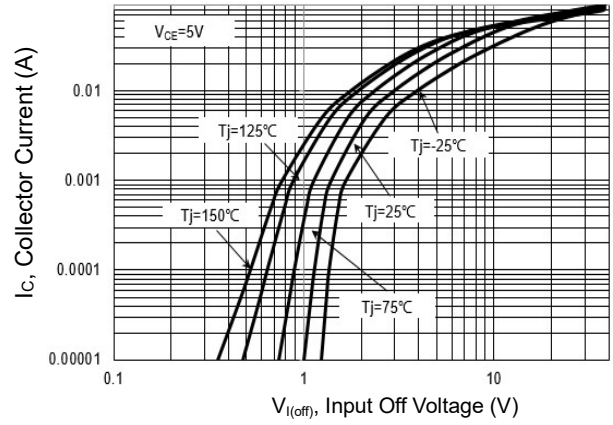

Fig 3. DC Current Gain vs. Collector Current

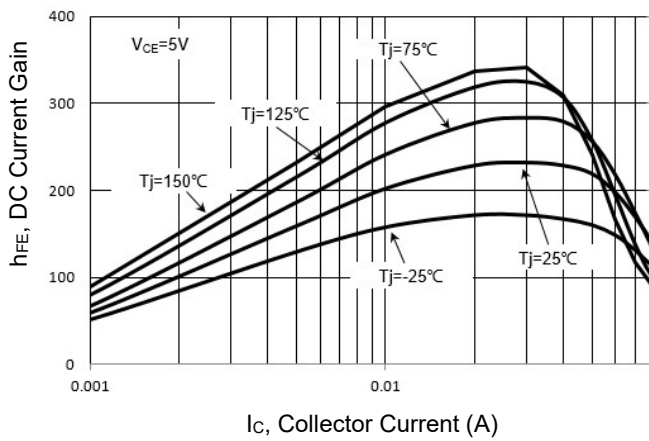
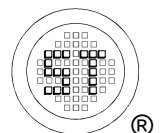
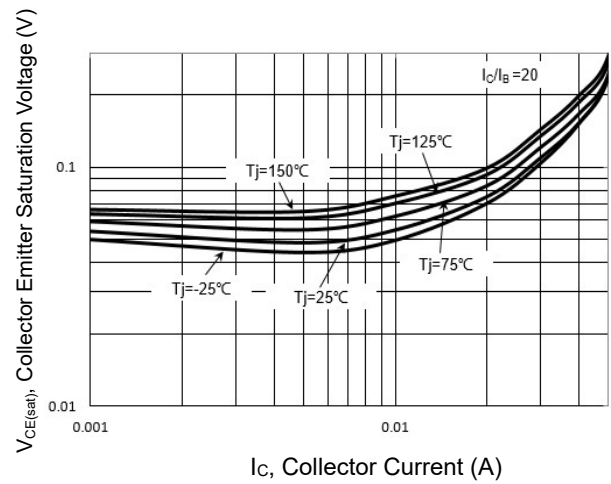

Fig 4. $V_{CE(sat)}$ vs. Collector Current



Electrical Characteristics Curves (MMDT1906DW)

Fig 1. Collector Current vs. $V_{I(ON)}$

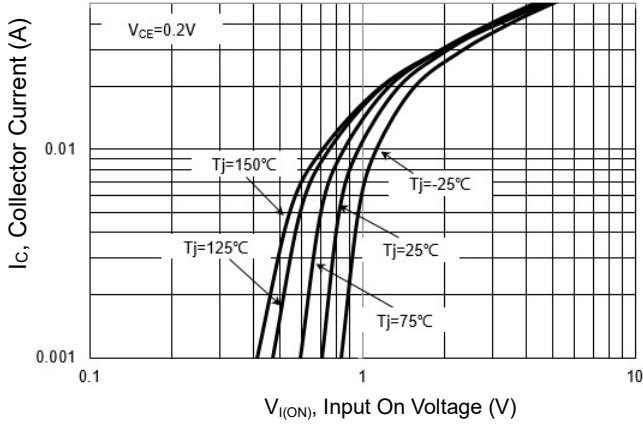

Fig 2. Collector Current vs. $V_{I(off)}$

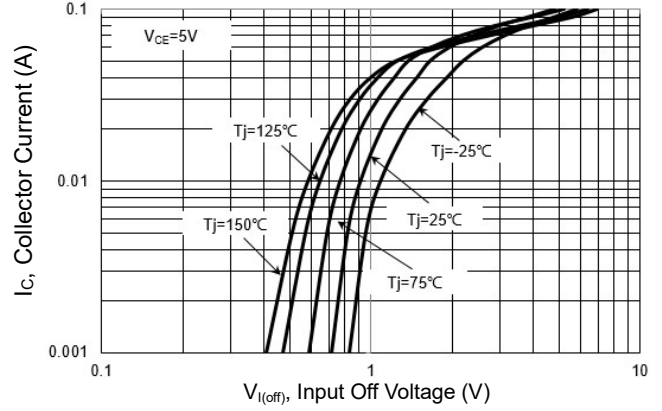

Fig 3. DC Current Gain vs. Collector Current

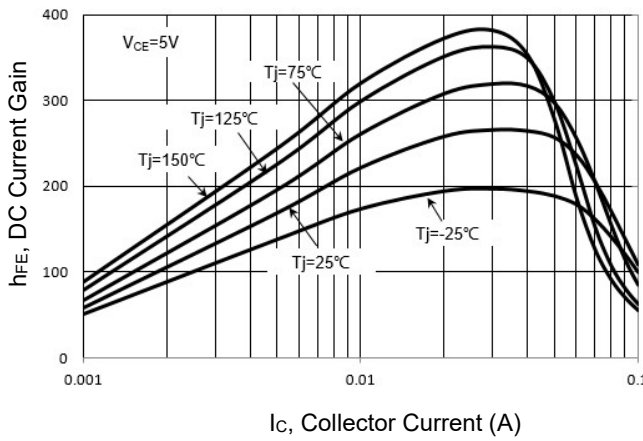
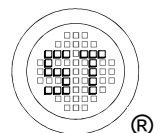
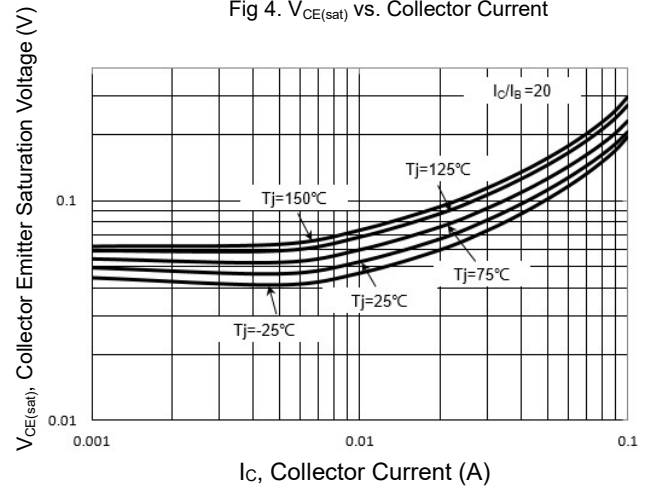

Fig 4. $V_{CE(sat)}$ vs. Collector Current



MMDT1901DW...MMDT1909DW

Electrical Characteristics Curves (MMDT1908DW)

Fig 1. Collector Current vs. $V_{I(ON)}$

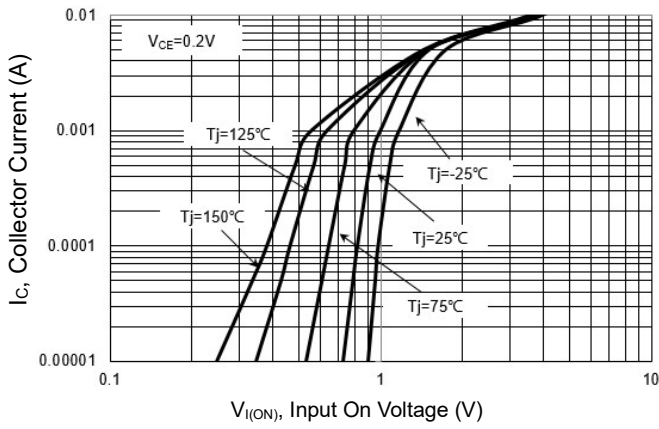

Fig 2. Collector Current vs. $V_{I(off)}$

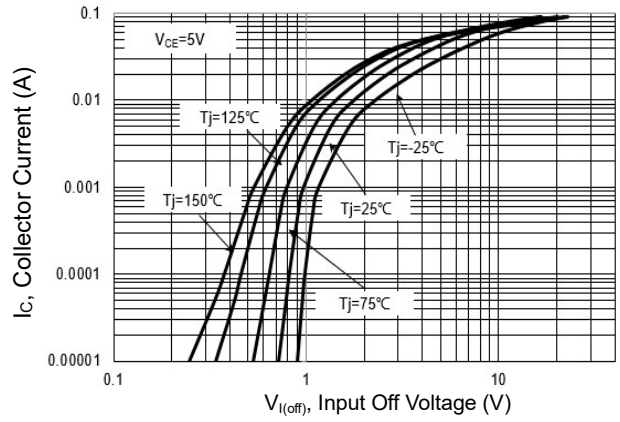

Fig 3. DC Current Gain vs. Collector Current

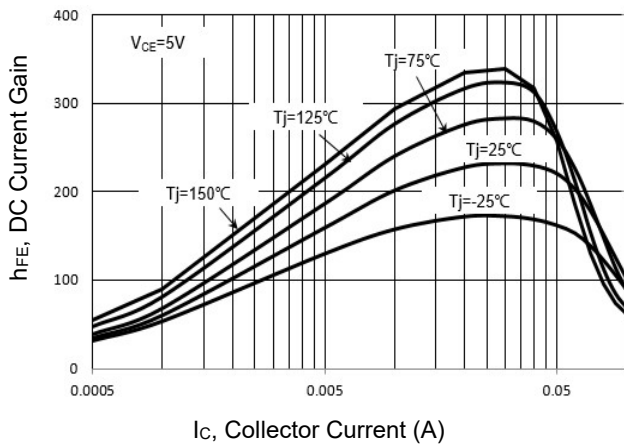
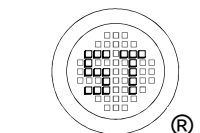
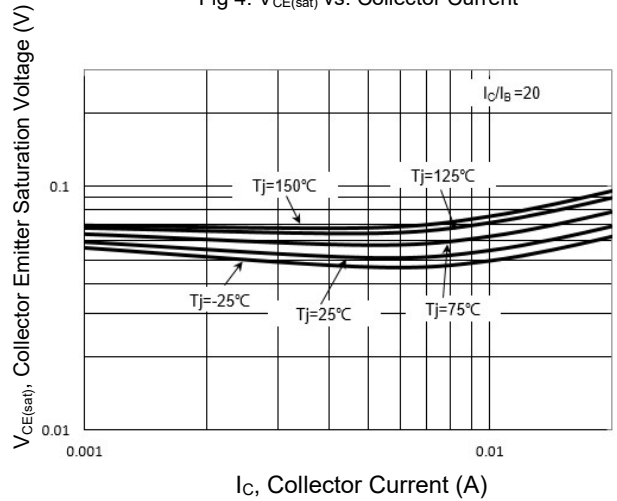

Fig 4. $V_{CE(sat)}$ vs. Collector Current



MMDT1901DW...MMDT1909DW

Electrical Characteristics Curves (MMDT1909DW)

Fig 1. Collector Current vs. $V_{I(ON)}$

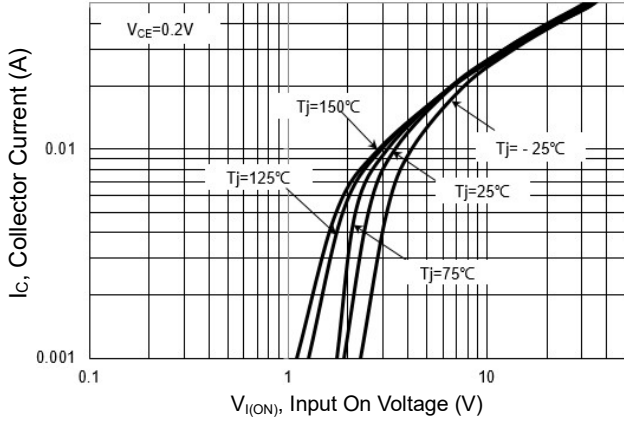

Fig 2. Collector Current vs. $V_{I(off)}$

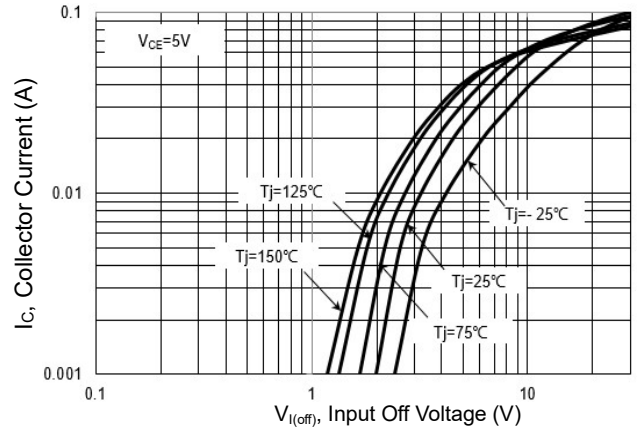

Fig 3. DC Current Gain vs. Collector Current

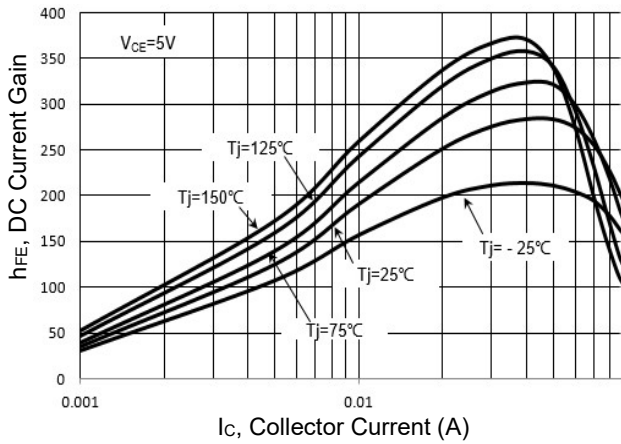
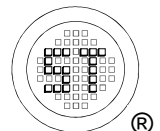
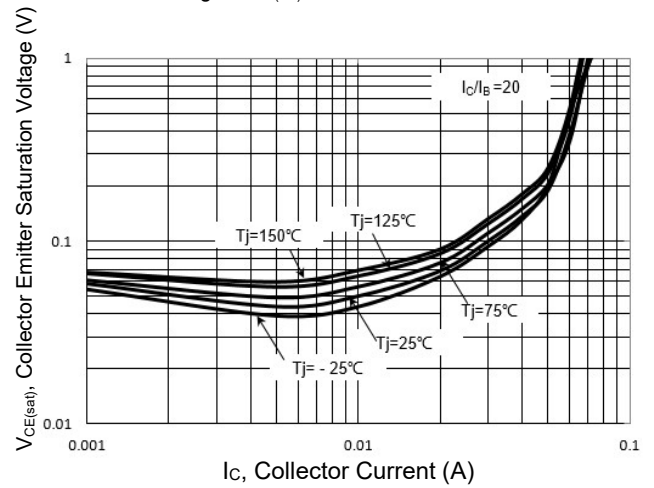

Fig 4. $V_{CE(sat)}$ vs. Collector Current



MMDT1901DW...MMDT1909DW

Package Outline (Dimensions in mm)

SOT-363

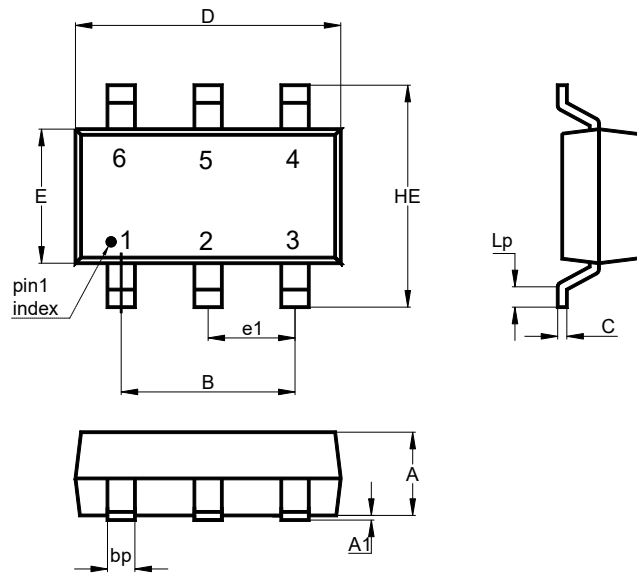

Unit	A	A1	B	C	D	E	e1	HE	Lp	bp
mm	1.0	0.1	1.3	0.25	2.2	1.35	0.65	2.2	0.4	0.3
	0.9	0	typ.	0.1	1.8	1.15	typ.	2.0	0.15	0.1

Recommended Soldering Footprint

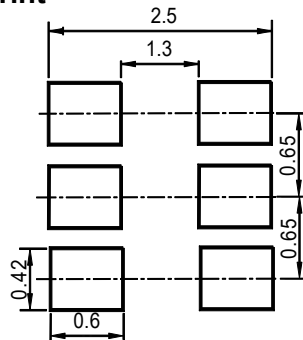

Packing information

Package	Tape Width (mm)	Pitch		Reel Size		Per Reel Packing Quantity
		mm	inch	mm	inch	
SOT-363	8	4 ± 0.1	0.157 ± 0.004	178	7	3,000

Marking information

"**" = Part No.

Type	Marking	Type	Marking	Type	Marking
MMDT1901DW	XA	MMDT1904DW	XD	MMDT1907DW	XG
MMDT1902DW	XB	MMDT1905DW	XE	MMDT1908DW	XH
MMDT1903DW	XC	MMDT1906DW	XF	MMDT1909DW	XJ

"YM" = Date Code Marking

"Y" = Year

"M" = Month

Font type: Arial

