

MMBT7292K

N-Channel Enhancement Mode MOSFET

Features

- Low on resistance $R_{DS(ON)}$
- Low gate threshold voltage
- Low input capacitance
- ESD protected up to 2KV

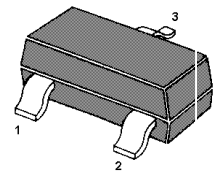
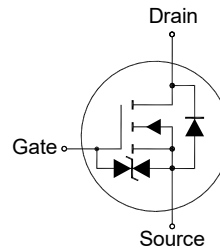

1.Gate 2.Source 3.Drain
SOT-23 Plastic Package

Absolute Maximum Ratings ($T_a = 25^\circ\text{C}$)

Parameter	Symbol	Value	Unit
Drain-Source Voltage	V_{DSS}	60	V
Gate-Source Voltage	V_{GSS}	± 20	V
Drain Current (Continuous)	I_D	300	mA
Drain Current (Pulse Width $\leq 10 \mu\text{s}$)	I_{DM}	800	mA
Total Power Dissipation	P_{tot}	350	mW
Operating Junction and Storage Temperature Range	T_j, T_{stg}	- 55 to + 150	$^\circ\text{C}$

Thermal Characteristics

Parameter	Symbol	Value	Unit
Thermal Resistance-Junction to Ambient ¹⁾	$R_{\theta JA}$	357	$^\circ\text{C/W}$

¹⁾ Device mounted on FR-4 substrate PC board, with minimum recommended pad layout.

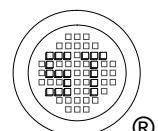

MMBT7292K

Characteristics at $T_a = 25^\circ\text{C}$ unless otherwise specified

Parameter	Symbol	Min.	Typ.	Max.	Unit
STATIC PARAMETERS					
Drain Source Breakdown Voltage at $I_D = 10 \mu\text{A}$	BV_{DSS}	60	-	-	V
Zero Gate Voltage Drain Current at $V_{DS} = 60 \text{ V}$	I_{DSS}	-	-	1	μA
Gate Source Leakage Current at $V_{GS} = \pm 20 \text{ V}$	I_{GSS}	-	-	± 10	μA
Gate Threshold Voltage at $V_{DS} = V_{GS}$, $I_D = 250 \mu\text{A}$	$V_{GS(th)}$	1	-	2.5	V
Static Drain Source On-Resistance at $V_{GS} = 10 \text{ V}$, $I_D = 500 \text{ mA}$ at $V_{GS} = 4.5 \text{ V}$, $I_D = 200 \text{ mA}$	$R_{DS(on)}$	-	-	3 4	Ω
DYNAMIC PARAMETERS					
Forward Transconductance at $V_{DS} = 10 \text{ V}$, $I_D = 200 \text{ mA}$	g_{FS}	80	-	-	mS
Gate Resistance at $V_{GS} = 0 \text{ V}$, $V_{DS} = 0 \text{ V}$, $f = 1 \text{ MHz}$	R_g	-	200	-	Ω
Input Capacitance at $V_{GS} = 0 \text{ V}$, $V_{DS} = 25 \text{ V}$, $f = 1 \text{ MHz}$	C_{iss}	-	22.5	50	pF
Output Capacitance at $V_{GS} = 0 \text{ V}$, $V_{DS} = 25 \text{ V}$, $f = 1 \text{ MHz}$	C_{oss}	-	9	25	pF
Reverse Transfer Capacitance at $V_{GS} = 0 \text{ V}$, $V_{DS} = 25 \text{ V}$, $f = 1 \text{ MHz}$	C_{rss}	-	7.5	10	pF
Gate charge total at $V_{DS} = 10 \text{ V}$, $I_D = 0.5 \text{ A}$, $V_{GS} = 4.5 \text{ V}$	Q_g	-	0.44	-	nC
Gate to Source Gate Charge at $V_{DS} = 10 \text{ V}$, $I_D = 0.5 \text{ A}$, $V_{GS} = 4.5 \text{ V}$	Q_{gs}	-	0.2	-	nC
Gate to Drain Charge at $V_{DS} = 10 \text{ V}$, $I_D = 0.5 \text{ A}$, $V_{GS} = 4.5 \text{ V}$	Q_{gd}	-	0.1	-	nC
Turn-On Delay Time at $V_{DS} = 30 \text{ V}$, $V_{GS} = 10 \text{ V}$, $I_D = 0.5 \text{ A}$, $R_G = 25 \Omega$	$t_{d(on)}$	-	2.7	-	ns
Turn-On Rise Time at $V_{DS} = 30 \text{ V}$, $V_{GS} = 10 \text{ V}$, $I_D = 0.5 \text{ A}$, $R_G = 25 \Omega$	t_r	-	2.5	-	ns
Turn-Off Delay Time at $V_{DS} = 30 \text{ V}$, $V_{GS} = 10 \text{ V}$, $I_D = 0.5 \text{ A}$, $R_G = 25 \Omega$	$t_{d(off)}$	-	13	-	ns
Turn-Off Fall Time at $V_{DS} = 30 \text{ V}$, $V_{GS} = 10 \text{ V}$, $I_D = 0.5 \text{ A}$, $R_G = 25 \Omega$	t_f	-	8	-	ns
Body-Diode PARAMETERS					
Drain-Source Diode Forward Voltage at $V_{GS} = 0 \text{ V}$, $I_S = 0.5 \text{ A}$	V_{SD}	-	0.85	-	V
Body Diode Reverse Recovery Time at $I_S = 0.5 \text{ A}$, $di/dt = 100 \text{ A} / \mu\text{s}$	t_{rr}	-	30	-	ns
Body Diode Reverse Recovery Charge at $I_S = 0.5 \text{ A}$, $di/dt = 100 \text{ A} / \mu\text{s}$	Q_{rr}	-	29	-	nC

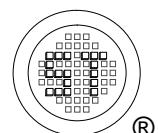

Electrical Characteristics Curves

Fig. 1 Typical Output Characteristic

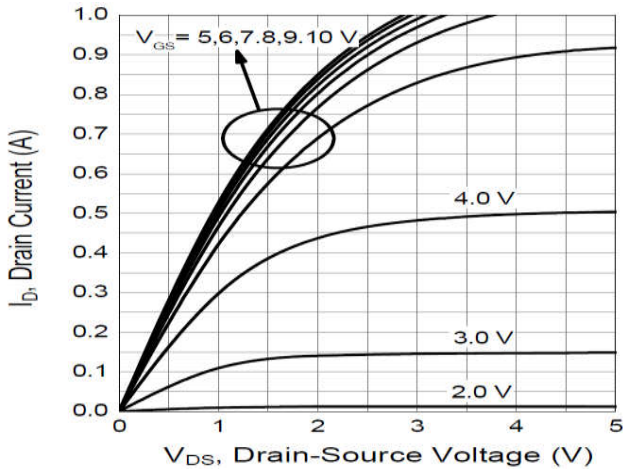

Fig. 2 Typical Transfer Characteristics

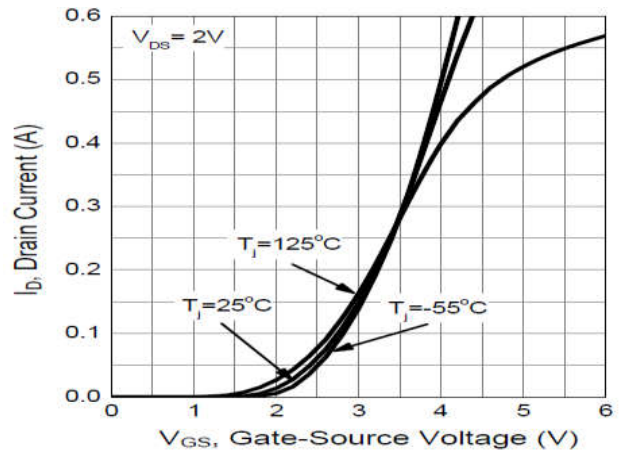

Fig. 3 Gate-Source Voltage vs. $R_{DS(on)}$

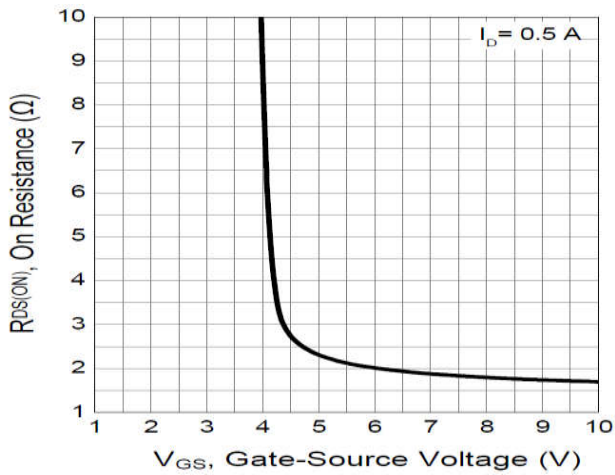

Fig. 4 on-Resistance vs. T_J

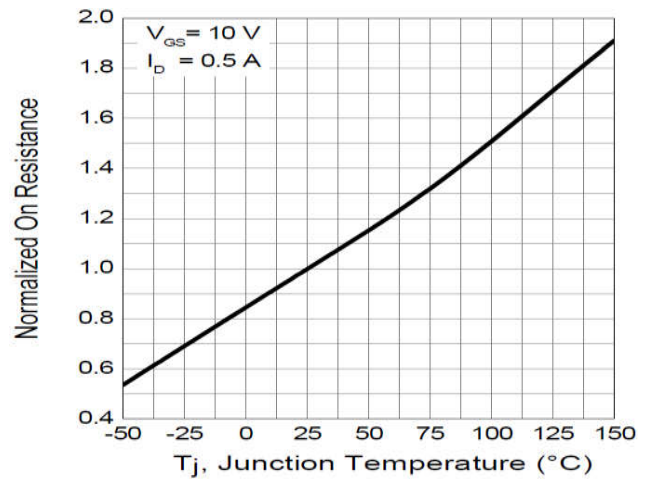

Fig. 5 Drain Current vs. on-Resistance

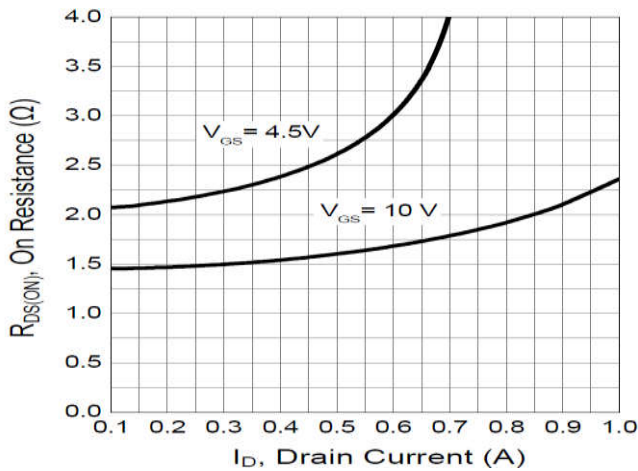
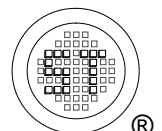
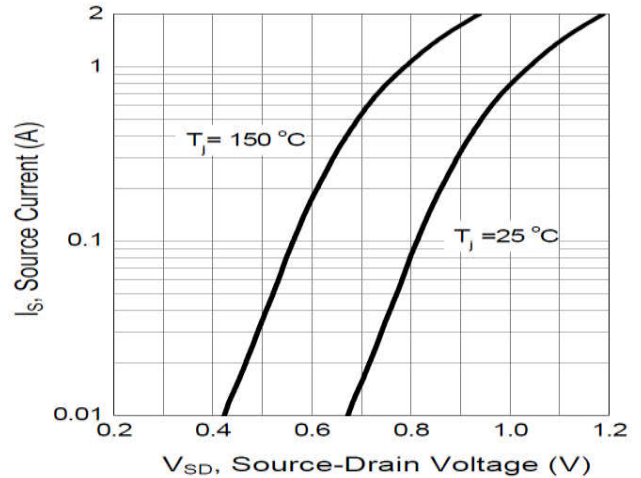

Fig. 6 Typical Forward Characteristic



MMBT7292K

Electrical Characteristics Curves

Fig. 7 Typical Junction Capacitance

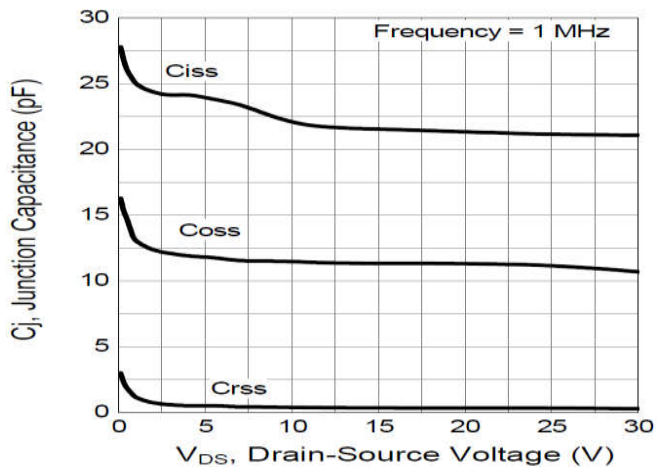

Fig. 8 Gate Charge

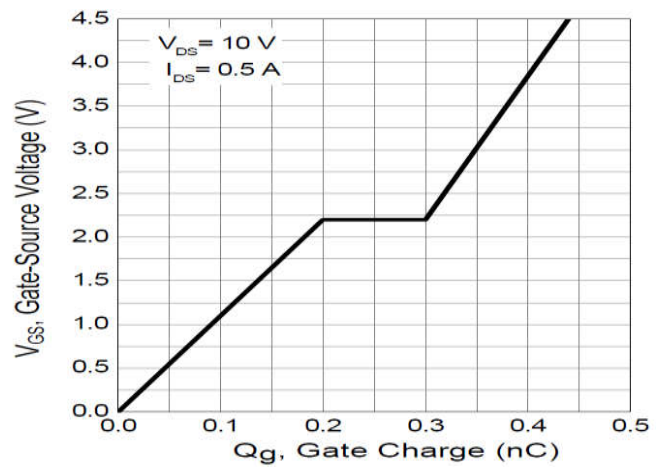
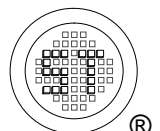
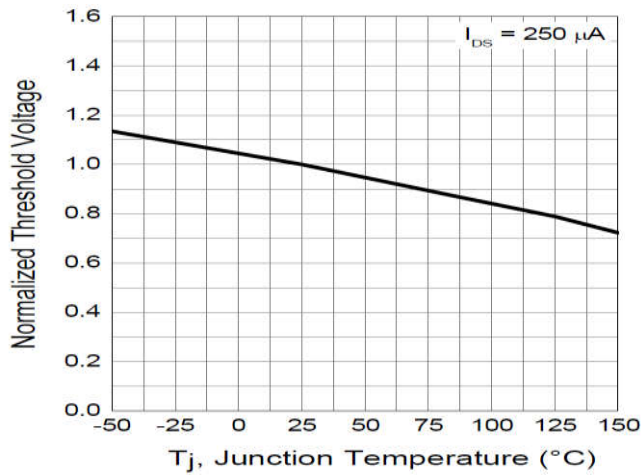

Fig. 9 Gate Threshold Variation vs. T_j



Test Circuits

Fig.1-1 Switching times test circuit

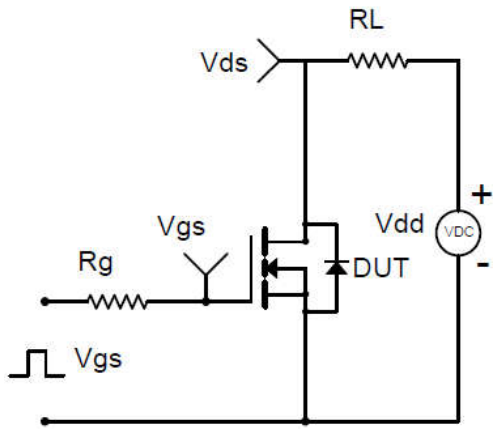

Fig.1-2 Switching Waveform

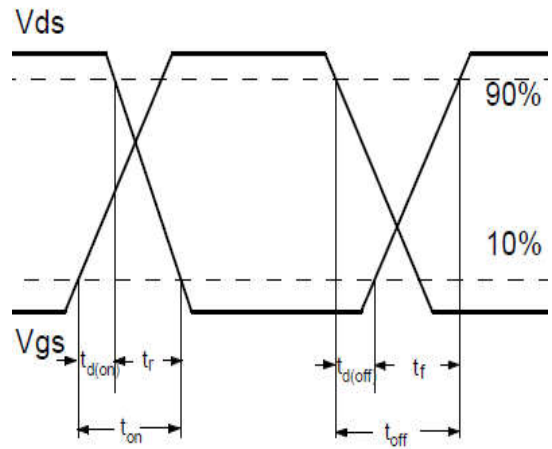

Fig.2-1 Gate charge test circuit

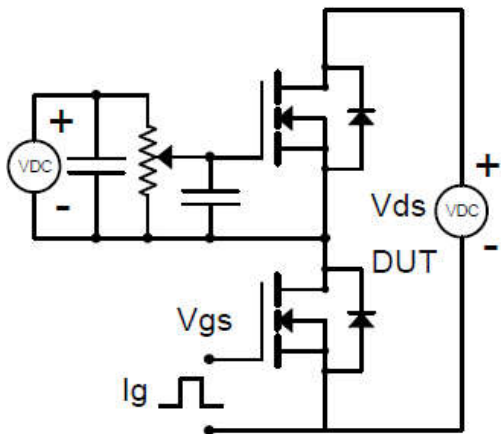
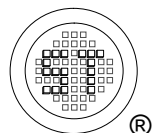
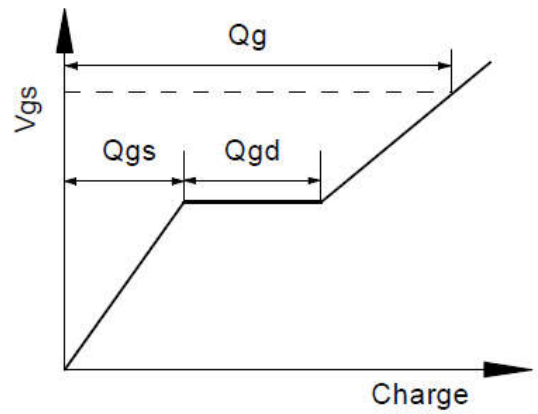

Fig.2-2 Gate charge waveform



MMBT7292K

PACKAGE OUTLINE

Plastic surface mounted package (Dimensions in mm)

SOT-23

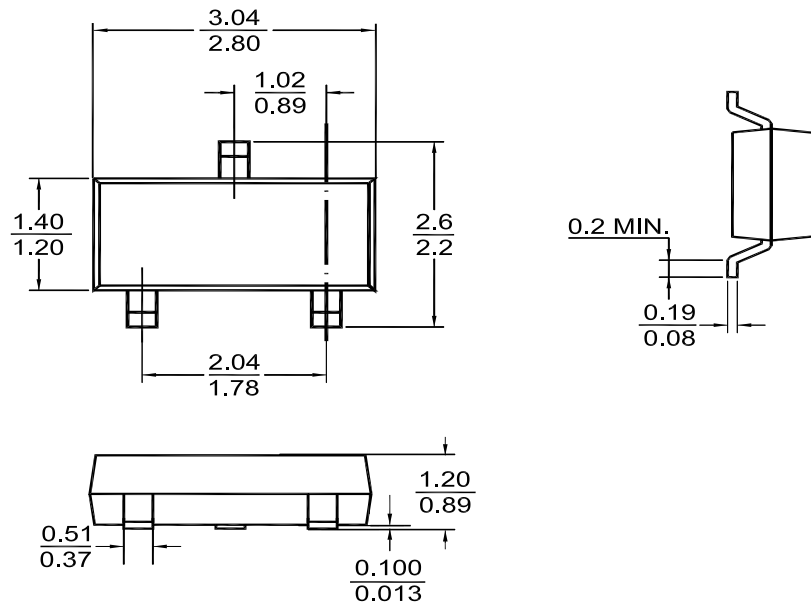

Recommended Soldering Footprint

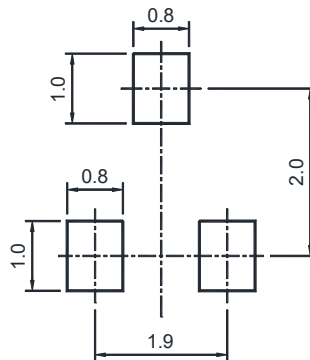

Packing information

Package	Tape Width (mm)	Pitch		Reel Size		Per Reel Packing Quantity
		mm	inch	mm	inch	
SOT-23	8	4 ± 0.1	0.157 ± 0.004	178	7	3,000

Marking information

" K72 " = Part No.
 "YM" = Date Code Marking
 "Y" = Year
 "M" = Month
 Font type: Arial

