

MMBT7002AK

N-Channel Enhancement Mode MOSFET

Features

- Very fast switching
- Typical ESD Protection HBM Class 2

Classification	Voltage Range(V)
0A	< 125
0B	125 to < 250
1A	250 to < 500
1B	500 to < 1000
1C	1000 to < 2000
2	2000 to < 4000
3A	4000 to < 8000
3B	≥ 8000

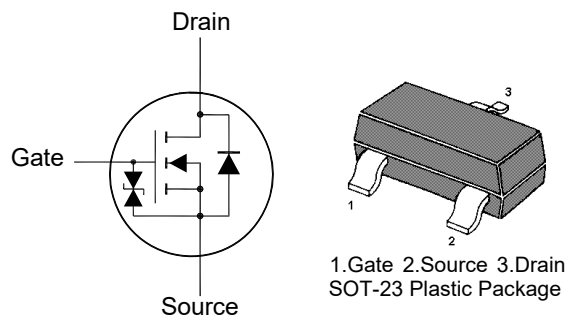

Application

- Portable appliances
- Battery management

Absolute Maximum Ratings (at $T_a = 25^\circ\text{C}$ unless otherwise specified)

Parameter	Symbol	Value	Unit
Drain-Source Voltage	V_{DS}	60	V
Gate-Source Voltage	V_{GS}	± 20	V
Drain Current (Continuous)	I_D	190	mA
Peak Drain Current (Pulse Width $\leq 10 \mu\text{s}$)	I_{DM}	1.5	A
Total Power Dissipation ¹⁾	P_D	350	mW
Operating Junction and Storage Temperature Range	T_j, T_{stg}	- 55 to + 150	$^\circ\text{C}$

Thermal Characteristics

Parameter	Symbol	Value	Unit
Thermal Resistance-Junction to Ambient ¹⁾	$R_{\theta JA}$	357	$^\circ\text{C/W}$

¹⁾ Device mounted on FR-4 substrate PC board, with minimum recommended pad layout.

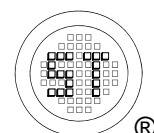

MMBT7002AK

Characteristics at $T_a = 25^\circ\text{C}$ unless otherwise specified

Parameter	Symbol	Min.	Typ.	Max.	Unit
STATIC PARAMETERS					
Drain-Source Breakdown Voltage at $I_D = 250 \mu\text{A}$	BV_{DSS}	60	-	-	V
Drain-Source Leakage Current at $V_{DS} = 60 \text{ V}$	I_{DSS}	-	-	1	μA
Gate Leakage Current at $V_{GS} = \pm 20 \text{ V}$ at $V_{GS} = \pm 10 \text{ V}$ at $V_{GS} = \pm 5 \text{ V}$	I_{GSS}	- - -	- - -	± 2 ± 0.5 ± 0.1	μA
Gate-Source Threshold Voltage at $V_{DS} = V_{GS}$, $I_D = 250 \mu\text{A}$	$V_{GS(th)}$	1.1	-	2.1	V
Drain-Source On-State Resistance at $V_{GS} = 10 \text{ V}$, $I_D = 100 \text{ mA}$ at $V_{GS} = 5 \text{ V}$, $I_D = 100 \text{ mA}$	$R_{DS(on)}$	- -	- -	4.5 5.2	Ω
DYNAMIC PARAMETERS					
Forward Transconductance at $V_{DS} = 10 \text{ V}$, $I_D = 200 \text{ mA}$	g_{FS}	-	230	-	mS
Gate Resistance at $V_{GS} = 0 \text{ V}$, $V_{DS} = 0 \text{ V}$, $f = 1 \text{ MHz}$	R_g	-	200	-	Ω
Input Capacitance at $V_{GS} = 0 \text{ V}$, $V_{DS} = 25 \text{ V}$, $f = 1 \text{ MHz}$	C_{iss}	-	22.5	50	pF
Output Capacitance at $V_{GS} = 0 \text{ V}$, $V_{DS} = 25 \text{ V}$, $f = 1 \text{ MHz}$	C_{oss}	-	12	25	pF
Reverse Transfer Capacitance at $V_{GS} = 0 \text{ V}$, $V_{DS} = 25 \text{ V}$, $f = 1 \text{ MHz}$	C_{rss}	-	0.5	10	pF
Gate charge total at $V_{DS} = 10 \text{ V}$, $I_D = 0.5 \text{ A}$, $V_{GS} = 4.5 \text{ V}$	Q_g	-	0.44	-	nC
Gate to Source Charge at $V_{DS} = 10 \text{ V}$, $I_D = 0.5 \text{ A}$, $V_{GS} = 4.5 \text{ V}$	Q_{gs}	-	0.2	-	nC
Gate to Drain Charge at $V_{DS} = 10 \text{ V}$, $I_D = 0.5 \text{ A}$, $V_{GS} = 4.5 \text{ V}$	Q_{gd}	-	0.1	-	nC
Turn-On Delay Time at $V_{GS} = 10 \text{ V}$, $I_D = 0.16 \text{ A}$, $V_{DS} = 40 \text{ V}$, $R_L = 250 \Omega$, $R_G = 6 \Omega$	$t_{d(on)}$	-	6	-	ns
Turn-On Rise Time at $V_{GS} = 10 \text{ V}$, $I_D = 0.16 \text{ A}$, $V_{DS} = 40 \text{ V}$, $R_L = 250 \Omega$, $R_G = 6 \Omega$	t_r	-	7	-	ns
Turn-Off Delay Time at $V_{GS} = 10 \text{ V}$, $I_D = 0.16 \text{ A}$, $V_{DS} = 40 \text{ V}$, $R_L = 250 \Omega$, $R_G = 6 \Omega$	$t_{d(off)}$	-	9	-	ns
Turn-Off Fall Time at $V_{GS} = 10 \text{ V}$, $I_D = 0.16 \text{ A}$, $V_{DS} = 40 \text{ V}$, $R_L = 250 \Omega$, $R_G = 6 \Omega$	t_f	-	85	-	ns
Body-Diode PARAMETERS					
Drain-Source Diode Forward Voltage at $V_{GS} = 0 \text{ V}$, $I_S = 115 \text{ mA}$	V_{SD}	0.47	-	1.2	V
Body-Diode Continuous Current	I_S	-	-	190	mA
Body Diode Reverse Recovery Time at $I_S = 0.5 \text{ A}$, $di/dt = 100 \text{ A} / \mu\text{s}$	t_{rr}	-	30	-	ns
Body Diode Reverse Recovery Charge at $I_S = 0.5 \text{ A}$, $di/dt = 100 \text{ A} / \mu\text{s}$	Q_{rr}	-	29	-	nC

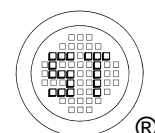

Electrical Characteristics Curves

Fig. 1 Typical Output Characteristics

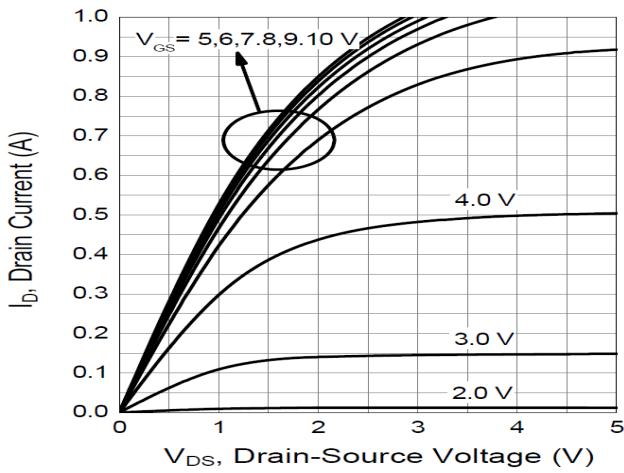

Fig. 2 Typical Transfer Characteristics

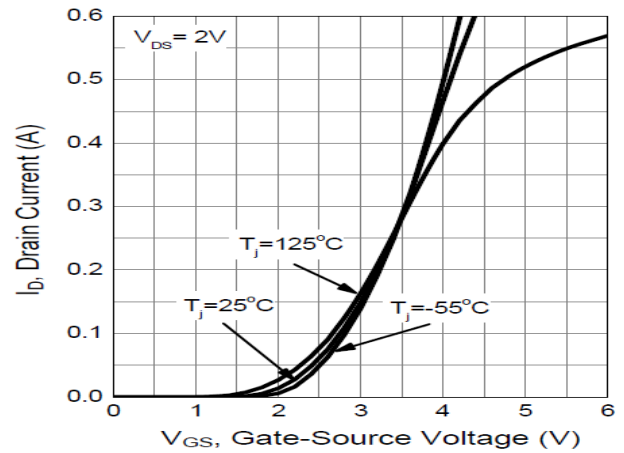

Fig. 3 Gate-Source Voltage vs. $R_{DS(on)}$

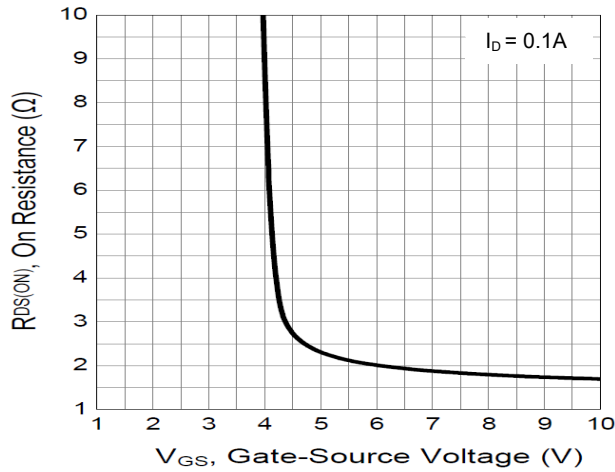

Fig. 4 on-Resistance vs. T_J

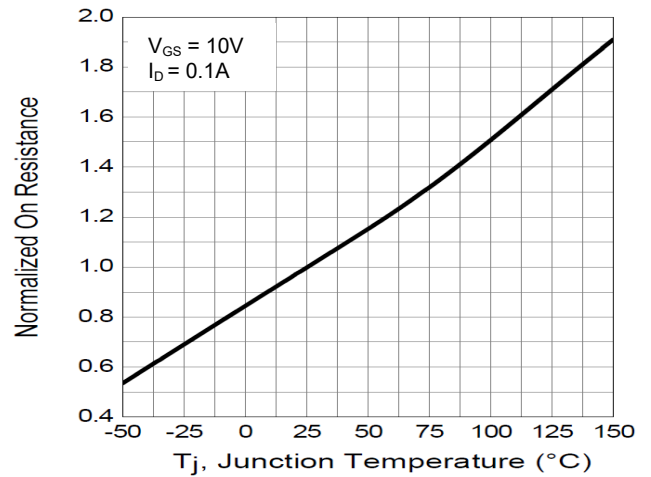

Fig. 5 Drain Current vs. on-Resistance

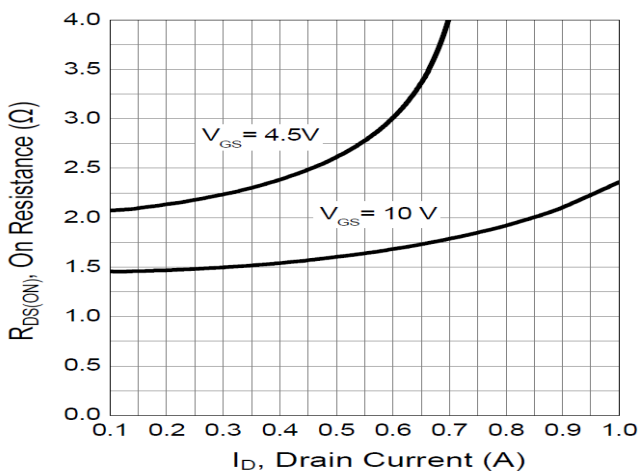
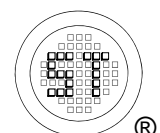
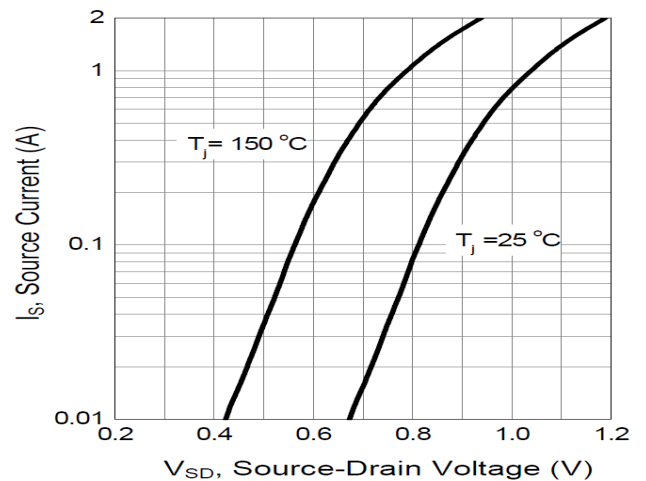

Fig. 6 Typical Forward Characteristics



MMBT7002AK

Electrical Characteristics Curves

Fig. 7 Typical Junction Capacitance

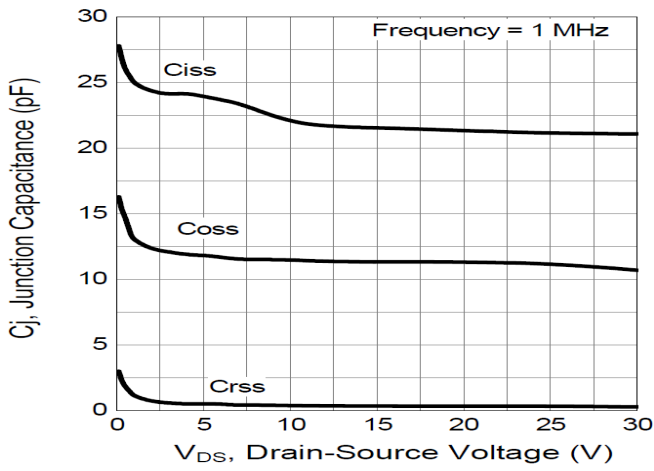

Fig. 8 Gate Charge

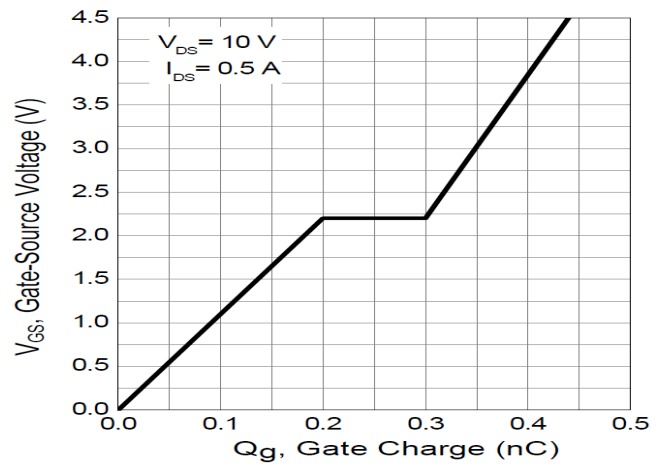
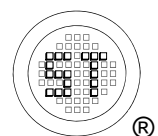
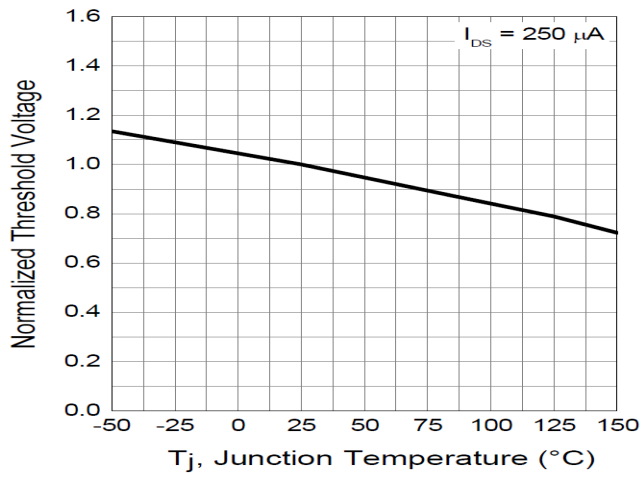

Fig. 9 Gate Threshold Variation vs. T_j



Test Circuits

Fig.1-1 Switching times test circuit

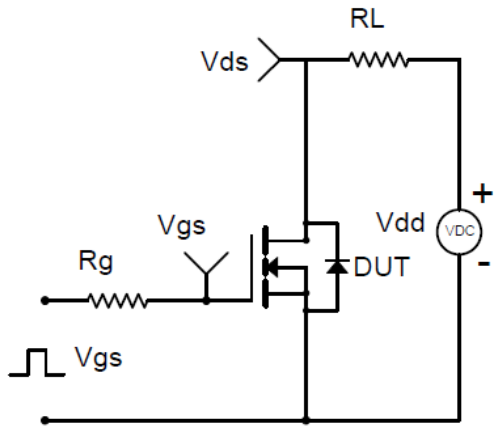

Fig.1-2 Switching Waveform

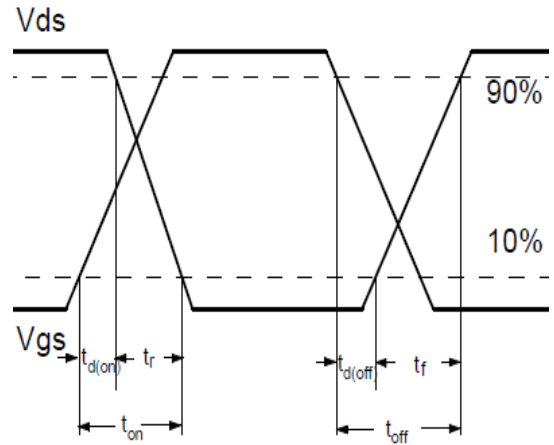

Fig.2-1 Gate charge test circuit

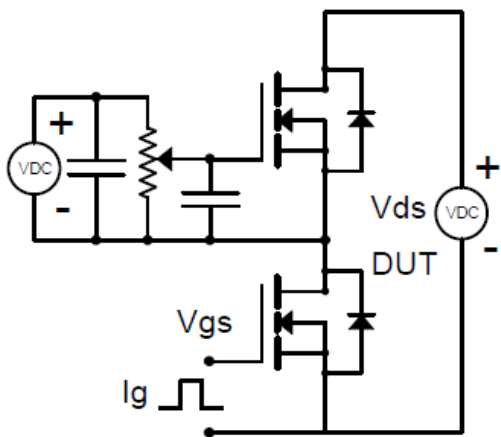
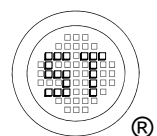
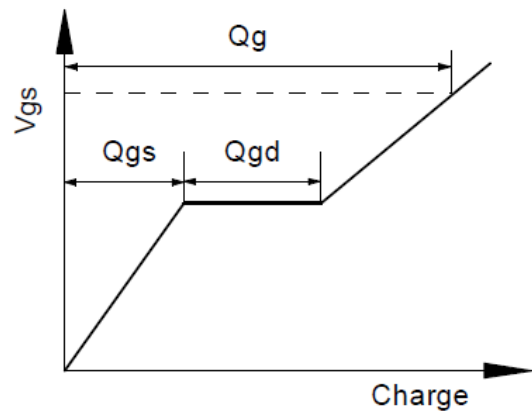

Fig.2-2 Gate charge waveform



MMBT7002AK

Package Outline (Dimensions in mm)

SOT-23

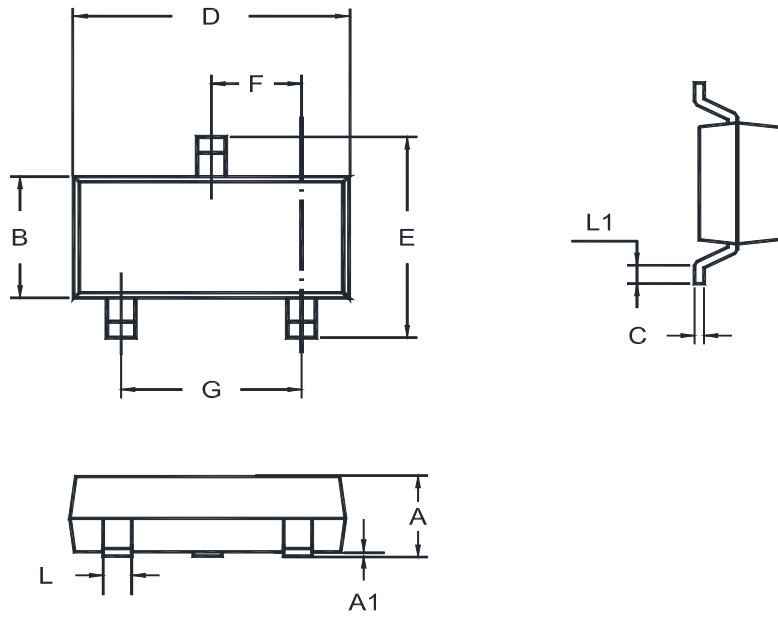

Unit	A	A1	B	C	D	E	F	G	L	L1
mm	1.20	0.100	1.40	0.19	3.04	2.6	1.02	2.04	0.51	0.2
	0.89	0.013	1.20	0.08	2.80	2.2	0.89	1.78	0.37	MIN

Recommended Soldering Footprint

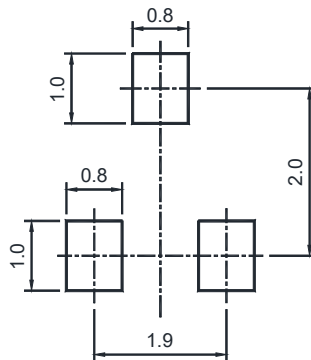

Packing information

Package	Tape Width (mm)	Pitch		Reel Size		Per Reel Packing Quantity
		mm	inch	mm	inch	
SOT-23	8	4 ± 0.1	0.157 ± 0.004	178	7	3,000

Marking information

- "K72" = Part No.
- "YM" = Date Code Marking
- "Y" = Year
- "M" = Month
- Font type: Arial

