

MKA03N650UK

N-Channel Enhancement Mode MOSFET

Features

- High speed switch
- Built-in G-S Protection Diode
- Typical ESD Protection HBM Class 1C

Classification	Voltage Range(V)
0A	< 125
0B	125 to < 250
1A	250 to < 500
1B	500 to < 1000
1C	1000 to < 2000
2	2000 to < 4000
3A	4000 to < 8000
3B	≥ 8000

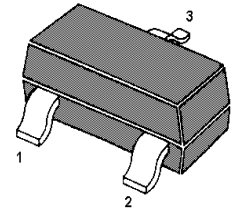
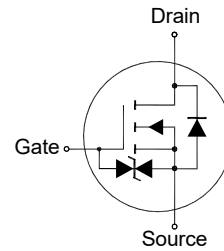

1. Gate 2. Source 3. Drain
SOT-23 Plastic Package

Applications

- Portable appliances
- Battery management
- Low power DC to DC Converter

Absolute Maximum Ratings (at $T_a = 25^\circ\text{C}$ unless otherwise specified)

Parameter	Symbol	Value	Unit
Drain-Source Voltage	V_{DS}	30	V
Gate-Source Voltage	V_{GS}	± 12	V
Drain Current	I_D	500	mA
Peak Drain Current ¹⁾	I_{DM}	1.7	A
Power Dissipation ²⁾	P_{tot}	450	mW
Operating Junction Temperature Range	T_j	- 55 to + 150	$^\circ\text{C}$
Storage Temperature Range	T_{stg}	- 55 to + 150	$^\circ\text{C}$

Thermal Characteristics

Parameter	Symbol	Max.	Unit
Thermal Resistance from Junction to Ambient ²⁾	$R_{\theta JA}$	275	$^\circ\text{C}/\text{W}$

¹⁾ Pulse Test: Pulse Width $\leq 100 \mu\text{s}$, Duty Cycle $\leq 2\%$, Repetitive rating, pulse width limited by junction temperature $T_{J(\text{MAX})}=150^\circ\text{C}$.

²⁾ Device mounted on FR-4 substrate PC board, 2oz copper, with 1-inch square copper plate in still air.

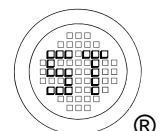

MKA03N650UK

Characteristics at $T_a = 25^\circ\text{C}$ unless otherwise specified

Parameter	Symbol	Min.	Typ.	Max.	Unit
STATIC PARAMETERS					
Drain-Source Breakdown Voltage at $I_D = 100 \mu\text{A}$	BV_{DSS}	30	-	-	V
Drain-Source Leakage Current at $V_{DS} = 30 \text{ V}$	I_{DSS}	-	-	1	μA
Gate Leakage Current at $V_{GS} = \pm 10 \text{ V}$	I_{GSS}	-	-	± 1	μA
Gate-Source Threshold Voltage at $V_{DS} = V_{GS}, I_D = 250 \mu\text{A}$	$V_{GS(th)}$	0.5	-	1.5	V
Drain-Source On-State Resistance at $V_{GS} = 4 \text{ V}, I_D = 10 \text{ mA}$ at $V_{GS} = 2.5 \text{ V}, I_D = 10 \text{ mA}$	$R_{DS(on)}$	-	-	650 750	$\text{m}\Omega$
DYNAMIC PARAMETERS					
Gate resistance at $V_{DS} = 0 \text{ V}, V_{GS} = 0 \text{ V}, f = 1 \text{ MHz}$	R_g	-	59	-	Ω
Forward Transconductance at $V_{DS} = 3 \text{ V}, I_D = 10 \text{ mA}$	g_{Fs}	-	100	-	mS
Input Capacitance at $V_{DS} = 15 \text{ V}, V_{GS} = 0 \text{ V}, f = 1 \text{ MHz}$	C_{iss}	-	43	-	pF
Output Capacitance at $V_{DS} = 15 \text{ V}, V_{GS} = 0 \text{ V}, f = 1 \text{ MHz}$	C_{oss}	-	13	-	pF
Reverse Transfer Capacitance at $V_{DS} = 15 \text{ V}, V_{GS} = 0 \text{ V}, f = 1 \text{ MHz}$	C_{rss}	-	9.5	-	pF
Total Gate Charge at $V_{DS} = 15 \text{ V}, I_D = 0.5 \text{ A}, V_{GS} = 10 \text{ V}$ at $V_{DS} = 15 \text{ V}, I_D = 0.5 \text{ A}, V_{GS} = 4.5 \text{ V}$	Q_g	-	1.72 0.7	-	nC
Gate Source Charge at $V_{DS} = 15 \text{ V}, I_D = 0.5 \text{ A}, V_{GS} = 10 \text{ V}$	Q_{gs}	-	0.35	-	nC
Gate Drain Charge at $V_{DS} = 15 \text{ V}, I_D = 0.5 \text{ A}, V_{GS} = 10 \text{ V}$	Q_{gd}	-	0.17	-	nC
Turn-On Delay Time at $V_{GS} = 10 \text{ V}, V_{DS} = 15 \text{ V}, I_D = 1 \text{ A}, R_G = 51 \Omega$	$t_{d(on)}$	-	10.5	-	ns
Turn-On Rise Time at $V_{GS} = 10 \text{ V}, V_{DS} = 15 \text{ V}, I_D = 1 \text{ A}, R_G = 51 \Omega$	t_r	-	4.8	-	ns
Turn-Off Delay Time at $V_{GS} = 10 \text{ V}, V_{DS} = 15 \text{ V}, I_D = 1 \text{ A}, R_G = 51 \Omega$	$t_{d(off)}$	-	10	-	ns
Turn-Off Fall Time at $V_{GS} = 10 \text{ V}, V_{DS} = 15 \text{ V}, I_D = 1 \text{ A}, R_G = 51 \Omega$	t_f	-	7.5	-	ns
Body-Diode PARAMETERS					
Diode Forward Voltage at $I_S = 10 \text{ mA}$	V_{SD}	-	0.7	1.2	V
Body-Diode Continuous Current	I_S	-	-	500	mA
Body Diode Reverse Recovery Time at $I_S = 1 \text{ A}, di/dt = 100 \text{ A} / \mu\text{s}$	t_{rr}	-	6.3	-	ns
Body Diode Reverse Recovery Charge at $I_S = 1 \text{ A}, di/dt = 100 \text{ A} / \mu\text{s}$	Q_{rr}	-	2	-	nC

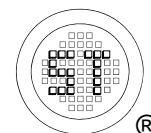

Electrical Characteristics Curves

Fig. 1 Typical Output Characteristics

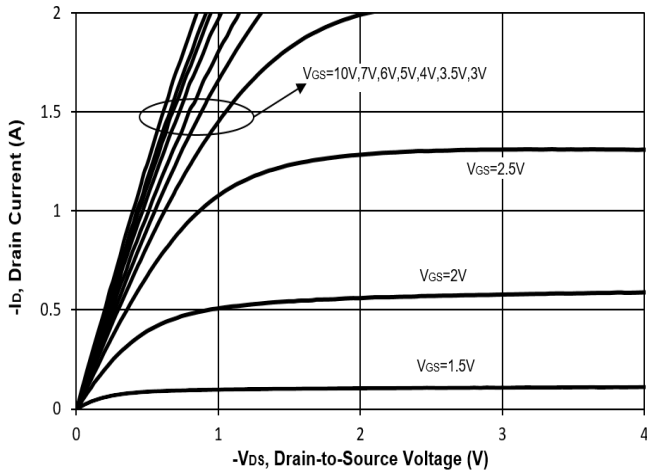

Fig. 2 Typical Transfer Characteristics

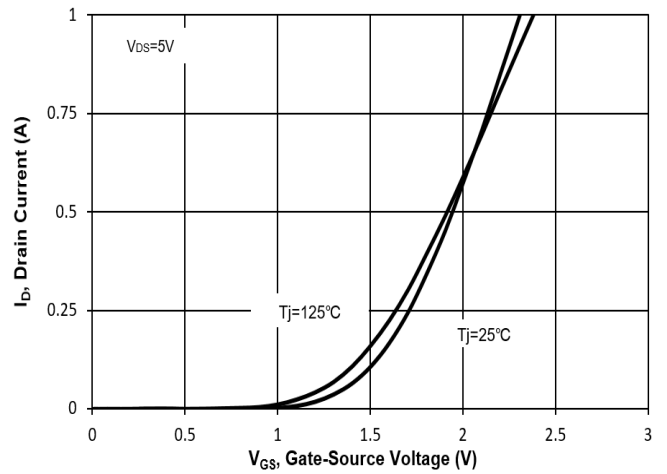

Fig. 3 on-Resistance vs. Drain Current

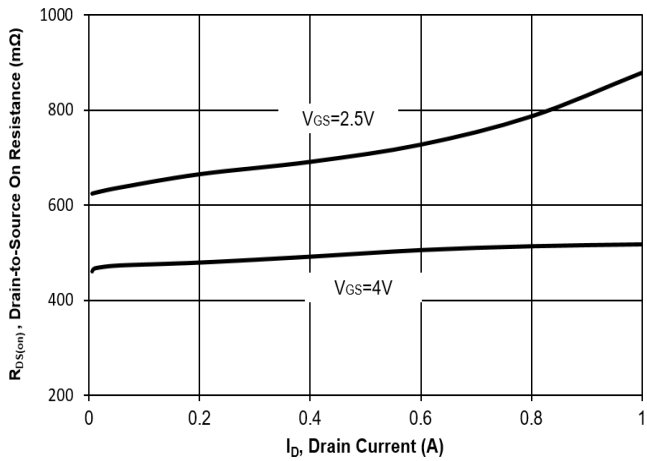

Fig. 4 on-Resistance vs. Gate-Source Voltage

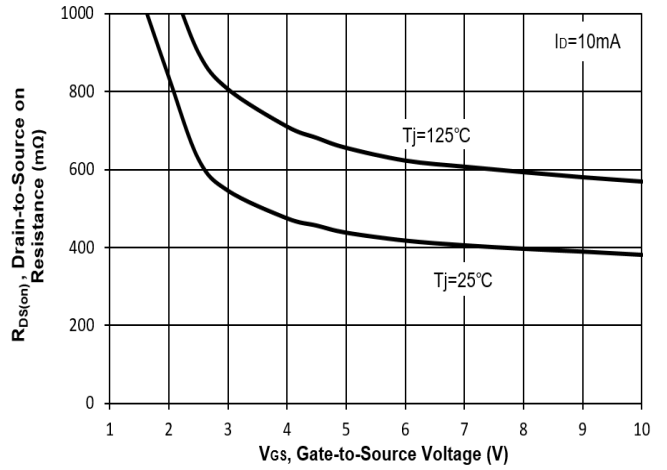

Fig. 5 on-Resistance vs. TJ

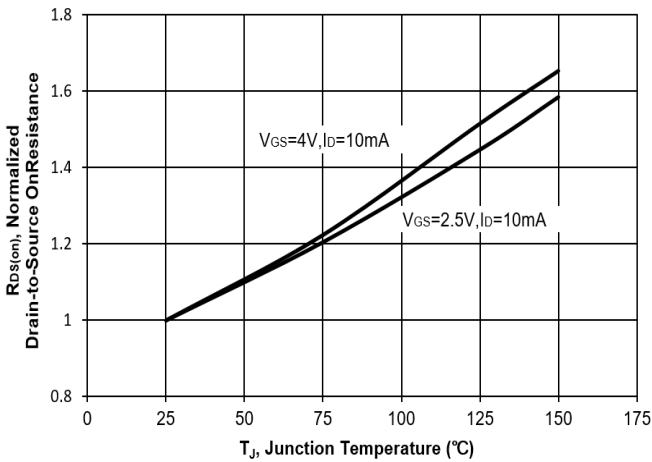
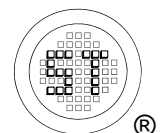
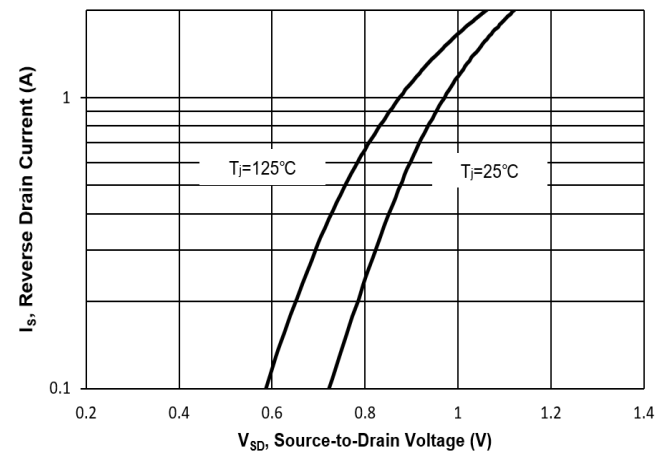

Fig. 6 Typical Forward Characteristics



Electrical Characteristics Curves

Fig. 7 Typical Junction Capacitance

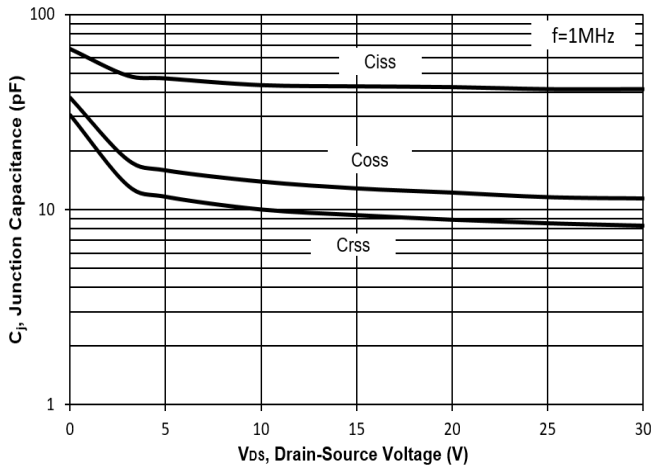

Fig. 8 Drain-Source Leakage Current vs. T_J

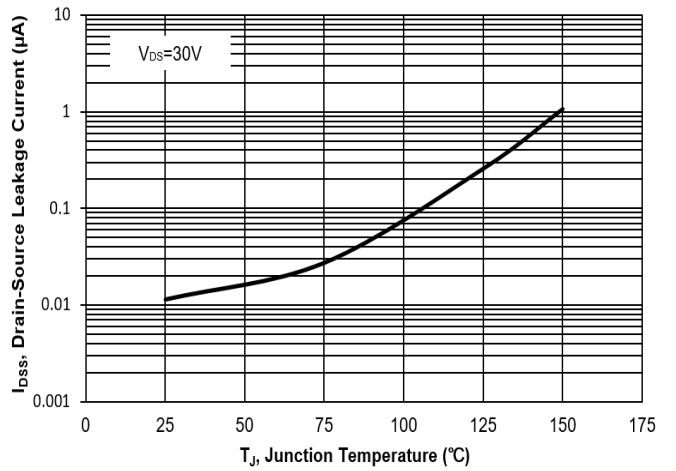

Fig. 9 V_{(BR)DSS} vs. Junction Temperature

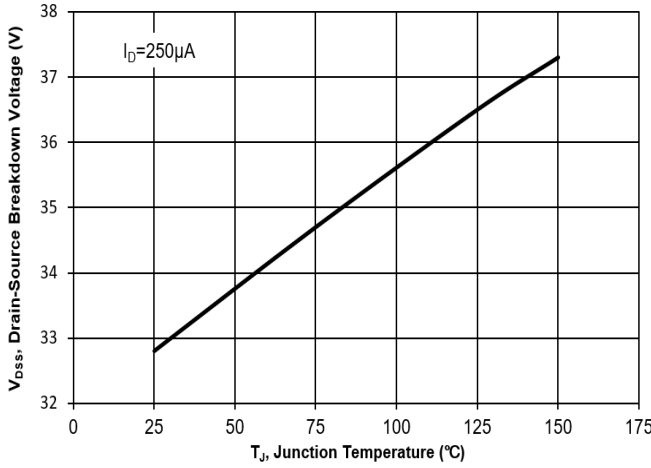

Fig. 10 Gate Threshold Variation vs. T_J

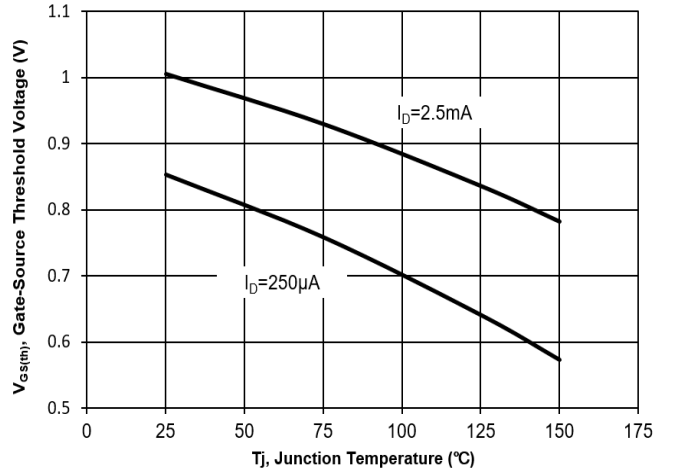
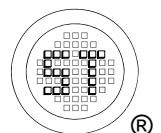
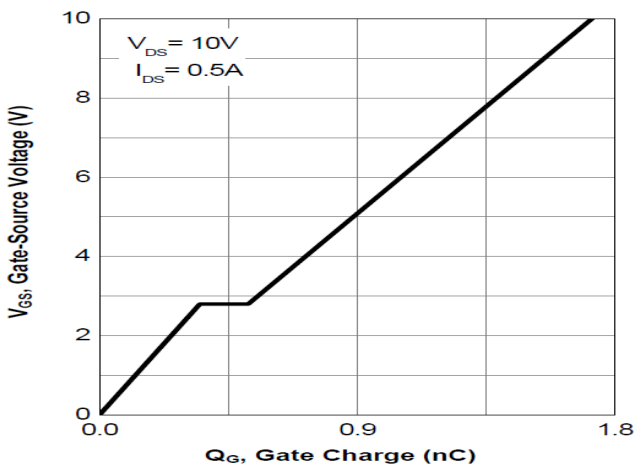

Fig. 11 Gate Charge



Test Circuits

Fig.1-1 Switching times test circuit

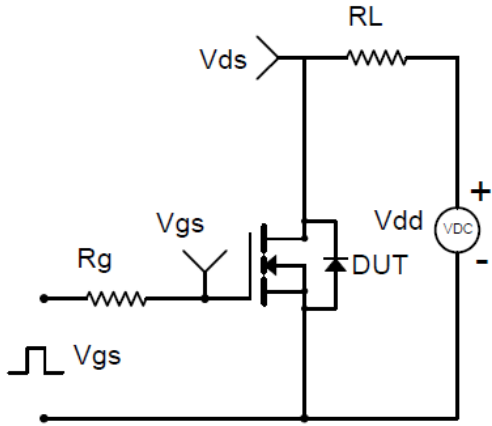

Fig.1-2 Switching Waveform

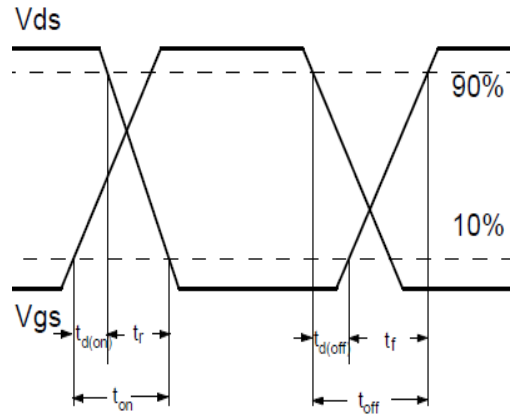

Fig.2-1 Gate charge test circuit

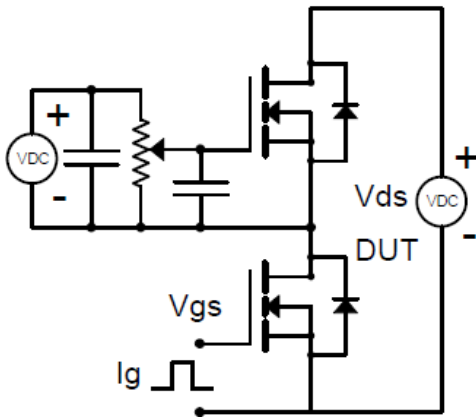
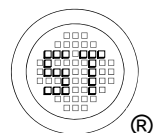
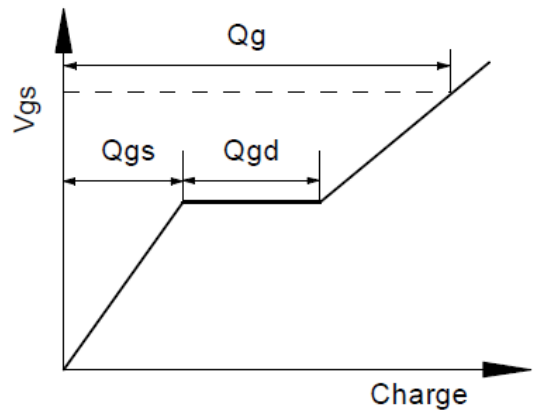

Fig.2-2 Gate charge waveform



MKA03N650UK

Package Outline (Dimensions in mm)

SOT-23

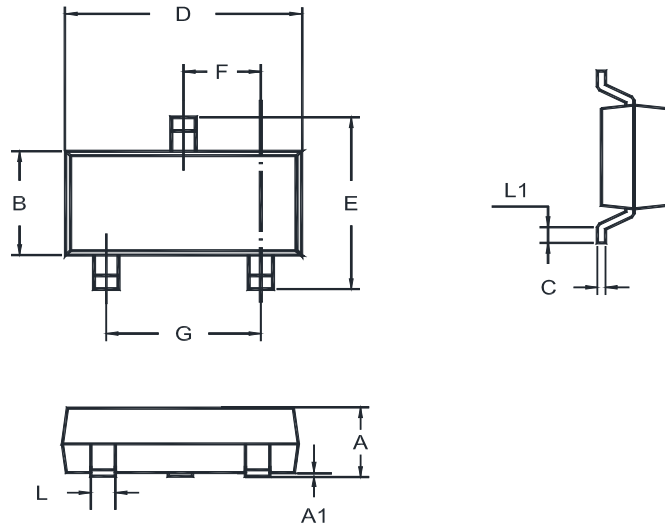

Unit	A	A1	B	C	D	E	F	G	L	L1
mm	1.20	0.100	1.40	0.19	3.04	2.6	1.02	2.04	0.51	0.2
	0.89	0.013	1.20	0.08	2.80	2.2	0.89	1.78	0.37	MIN

Recommended Soldering Footprint

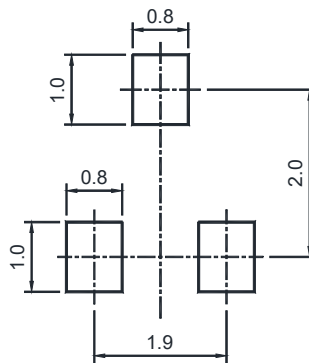

Packing information

Package	Tape Width (mm)	Pitch		Reel Size		Per Reel Packing Quantity
		mm	inch	mm	inch	
SOT-23	8	4 ± 0.1	0.157 ± 0.004	178	7	3,000

Marking information

- " M30 " = Part No.
 - " YM " = Date Code Marking
 - " Y " = Year
 - " M " = Month
- Font type: Arial

