

2SC4374U

NPN Silicon Epitaxial Planar Transistor

for general purpose applications

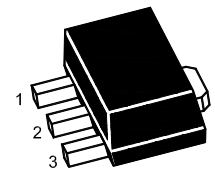

1.Base 2.Collector 3.Emitter
SOT-89 Plastic Package

Absolute Maximum Ratings ($T_a = 25^\circ\text{C}$)

Parameter	Symbol	Value	Unit
Collector Base Voltage	V_{CBO}	80	V
Collector Emitter Voltage	V_{CEO}	80	V
Emitter Base Voltage	V_{EBO}	5	V
Collector Current	I_C	400	mA
Base Current	I_B	80	mA
Total Power Dissipation	P_{tot}	0.5 1 ¹⁾	W
Junction Temperature	T_j	150	$^\circ\text{C}$
Storage Temperature Range	T_{stg}	- 55 to + 150	$^\circ\text{C}$

¹⁾ When mounted on a 250 mm² x 0.8 t ceramic substrate.

Characteristics at $T_a = 25^\circ\text{C}$

Parameter	Symbol	Min.	Typ.	Max.	Unit	
DC Current Gain at $V_{CE} = 2\text{ V}$, $I_C = 50\text{ mA}$ at $V_{CE} = 2\text{ V}$, $I_C = 200\text{ mA}$	Current Gain Group O	h_{FE}	70	-	140	-
	Y	h_{FE}	120	-	240	-
		h_{FE}	50	-	-	-
Collector Base Cutoff Current at $V_{CB} = 80\text{ V}$	I_{CBO}	-	-	100	nA	
Emitter Base Cutoff Current at $V_{EB} = 5\text{ V}$	I_{EBO}	-	-	100	nA	
Collector Emitter Breakdown Voltage at $I_C = 10\text{ mA}$	$V_{(BR)CEO}$	80	-	-	V	
Collector Emitter Saturation Voltage at $I_C = 200\text{ mA}$, $I_B = 20\text{ mA}$	$V_{CE(sat)}$	-	-	0.4	V	
Base Emitter Voltage at $V_{CE} = 2\text{ V}$, $I_C = 5\text{ mA}$	$V_{BE(on)}$	0.55	-	0.8	V	
Transition Frequency at $V_{CE} = 10\text{ V}$, $I_C = 10\text{ mA}$	f_T	-	100	-	MHz	
Collector Output Capacitance at $V_{CB} = 10\text{ V}$, $f = 1\text{ MHz}$	C_{ob}	-	10	-	pF	

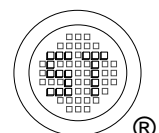

2SC4374U

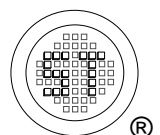
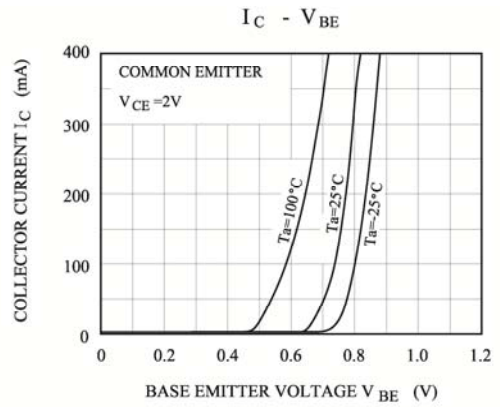
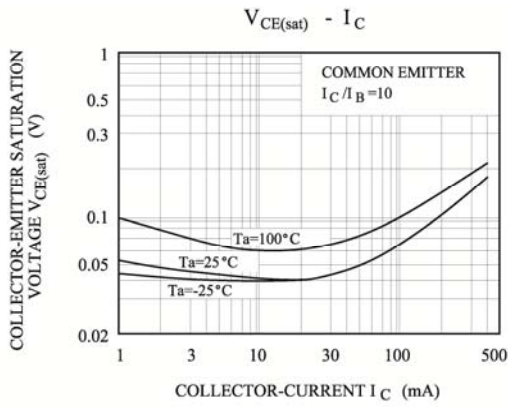
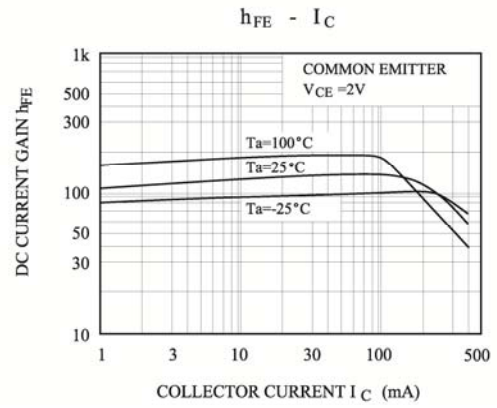
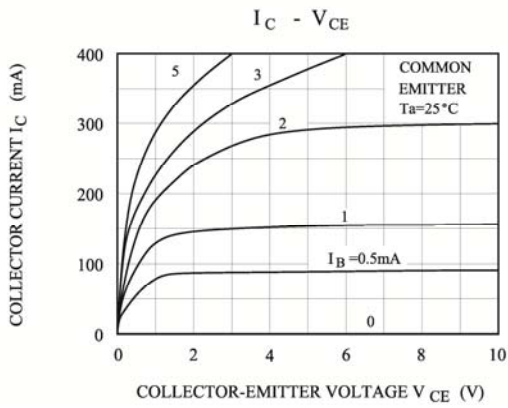

2SC4374U

SOT-89 PACKAGE OUTLINE

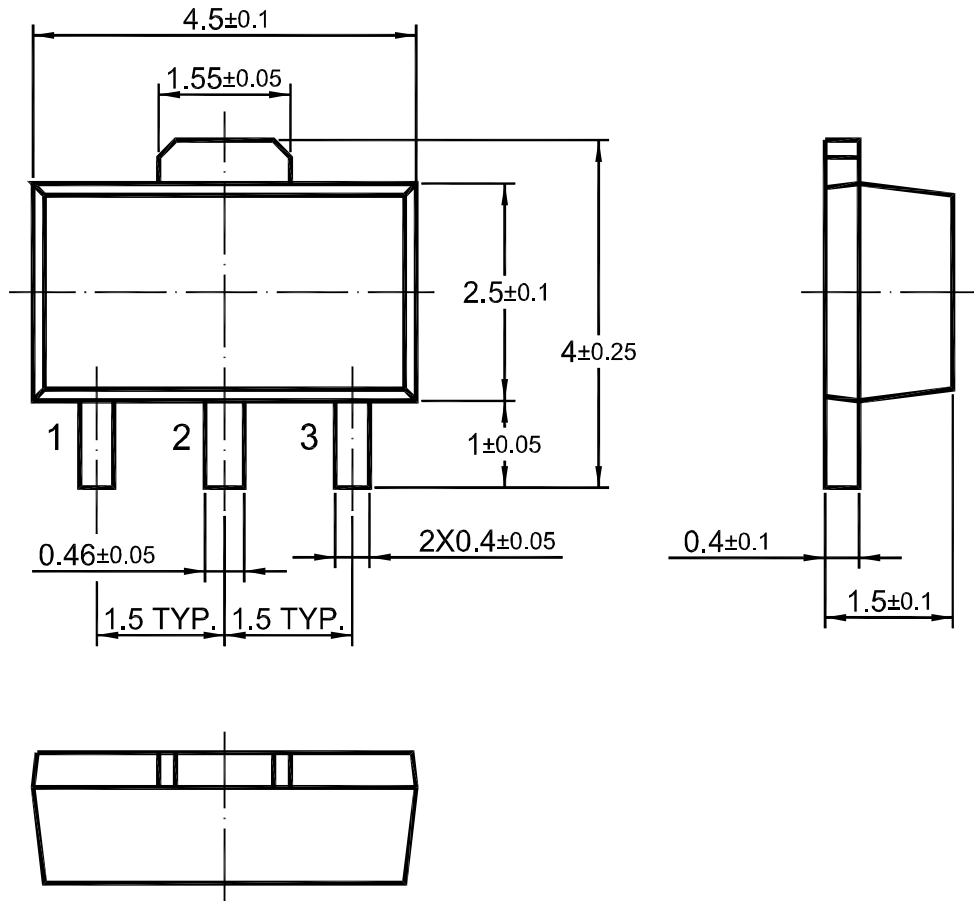

Dimensions in mm

