

2SB1424U

PNP Silicon Epitaxial Planar Transistor

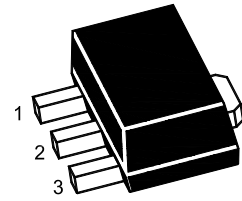

1.Base 2.Collector 3.Emitter
SOT-89 Plastic Package

Absolute Maximum Ratings ($T_a = 25^\circ\text{C}$)

Parameter	Symbol	Value	Unit
Collector Base Voltage	$-V_{\text{CBO}}$	20	V
Collector Emitter Voltage	$-V_{\text{CEO}}$	20	V
Emitter Base Voltage	$-V_{\text{EBO}}$	6	V
Collector Current - DC	$-I_{\text{C}}$	3	A
Collector Current - Pulse ¹⁾	$-I_{\text{CP}}$	5	A
Total Power Dissipation	P_{tot}	0.5	W
Junction Temperature	T_{j}	150	$^\circ\text{C}$
Storage Temperature Range	T_{stg}	- 55 to + 150	$^\circ\text{C}$

Thermal Characteristics

Parameter	Symbol	Max.	Unit
Thermal Resistance from Junction to Ambient ²⁾	$R_{\theta\text{JA}}$	250	$^\circ\text{C/W}$

¹⁾ Single pulse, PW = 10 ms.

²⁾ Device mounted on FR-4 substrate PC board, with minimum recommended pad layout.

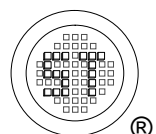

2SB1424U

Characteristics at $T_a = 25^\circ\text{C}$

Parameter	Symbol	Min.	Typ.	Max.	Unit
DC Current Gain at $-V_{CE} = 2\text{ V}$, $-I_C = 100\text{ mA}$	Current Gain Group Q R h_{FE} h_{FE}	120 180	- -	270 390	- -
Collector Base Cutoff Current at $-V_{CB} = 20\text{ V}$	$-I_{CBO}$	-	-	100	nA
Emitter Base Cutoff Current at $-V_{EB} = 5\text{ V}$	$-I_{EBO}$	-	-	100	nA
Collector Base Breakdown Voltage at $-I_C = 50\text{ }\mu\text{A}$	$-V_{(BR)CBO}$	20	-	-	V
Collector Emitter Breakdown Voltage at $-I_C = 1\text{ mA}$	$-V_{(BR)CEO}$	20	-	-	V
Emitter Base Breakdown Voltage at $-I_E = 50\text{ }\mu\text{A}$	$-V_{(BR)EBO}$	6	-	-	V
Collector Emitter Saturation Voltage at $-I_C = 2\text{ A}$, $-I_B = 100\text{ mA}$	$-V_{CE(sat)}$	-	-	0.5	V
Transition Frequency at $-V_{CE} = 2\text{ V}$, $-I_E = 0.5\text{ A}$, $f = 100\text{ MHz}$	f_T	-	240	-	MHz
Output Capacitance at $-V_{CB} = 10\text{ V}$, $f = 1\text{ MHz}$	C_{ob}	-	28	-	pF

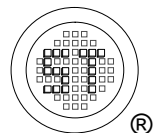

2SB1424U

Electrical Characteristics Curves

Fig. 1 Output Characteristics Curve

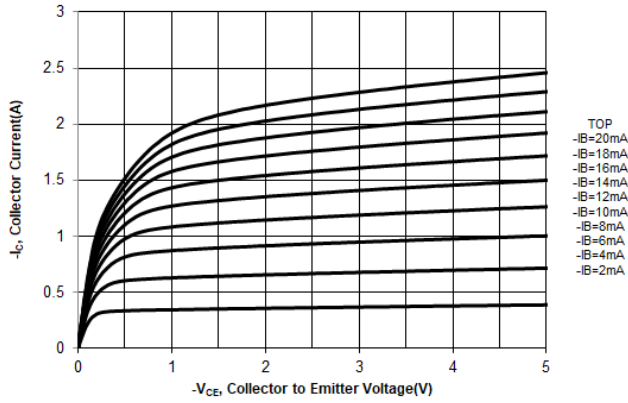

Fig. 2 Collector Current vs. Base to Emitter Voltage

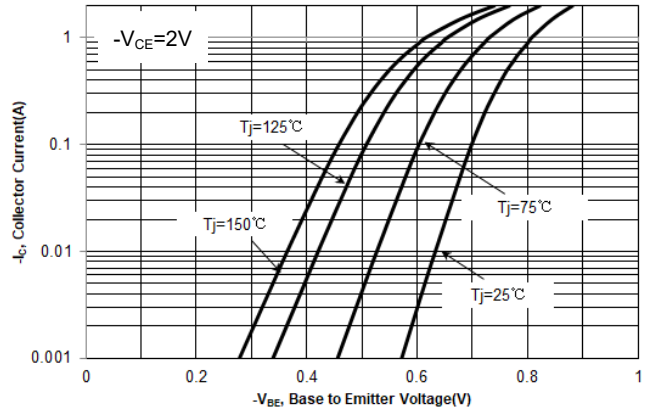

Fig. 3 DC Current Gain vs. Collector Current

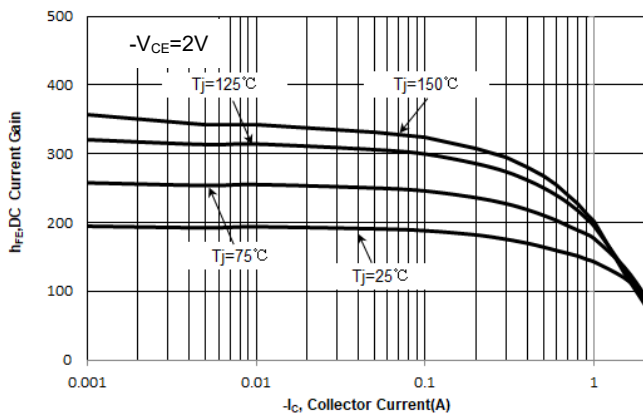
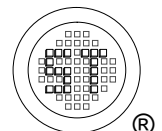
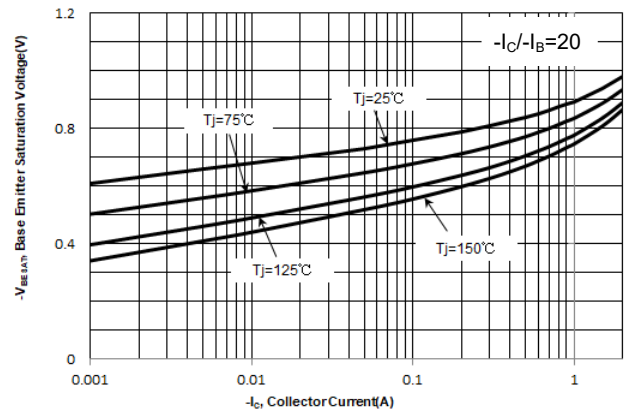

Fig. 4 V_{BESAT} vs. Collector Current



2SB1424U

Electrical Characteristics Curves

Fig. 5 V_{CESAT} vs. Collector Current

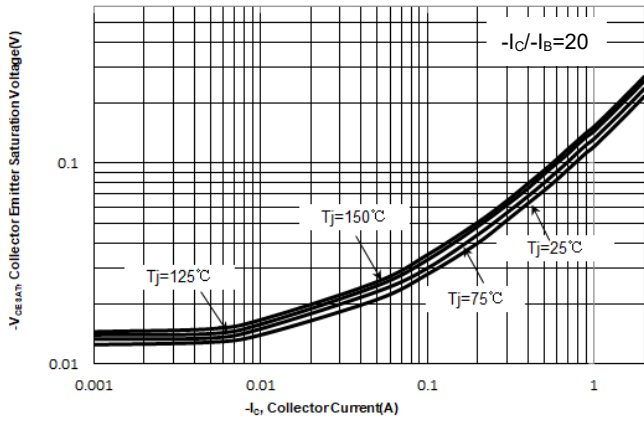

Fig. 6 Output Capacitance

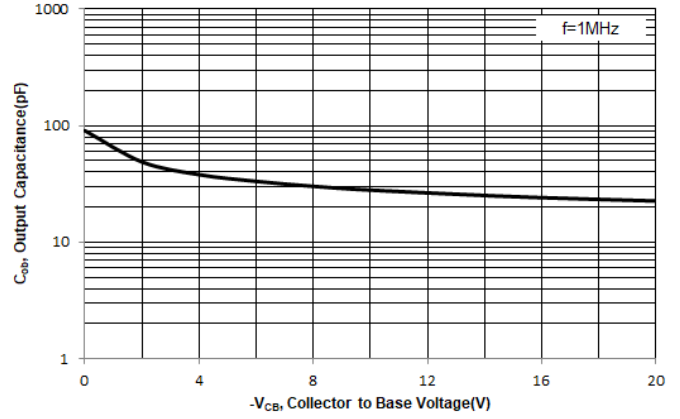
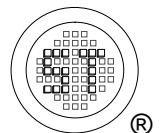
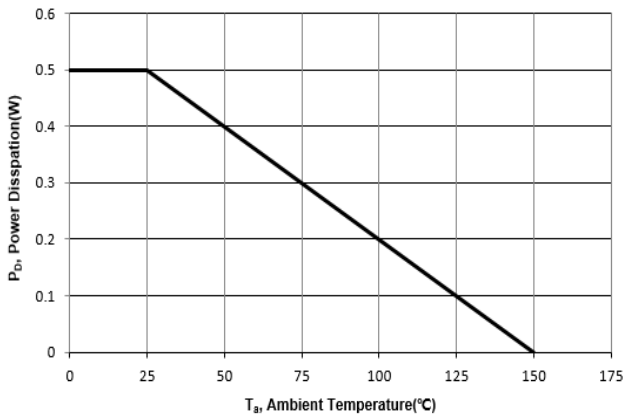

Fig. 7 Power Derating Curve



2SB1424U

Package Outline (Dimensions in mm)

SOT-89

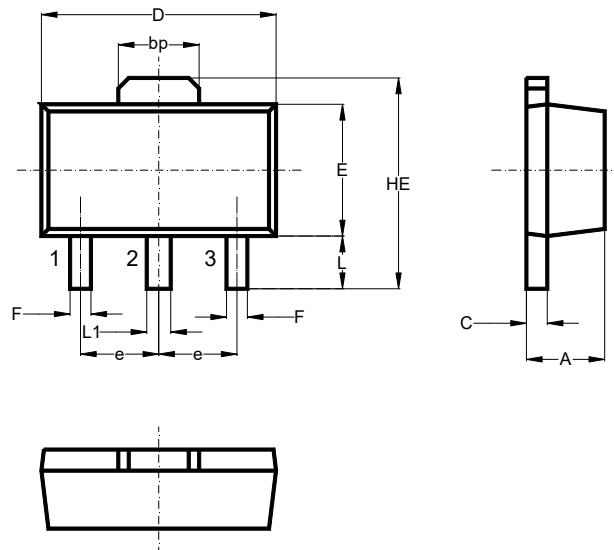

Unit	A	bp	C	D	E	F	HE	e	L	L1
mm	1.6	1.60	0.5	4.6	2.6	0.45	4.25	1.5	1.05	0.51
	1.4	1.50	0.3	4.4	2.4	0.35	3.75	typ.	0.95	0.41

Recommended Soldering Footprint

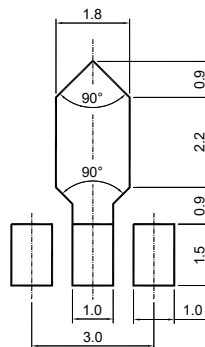

Packing information

Package	Tape Width (mm)	Pitch		Reel Size		Per Reel Packing Quantity
		mm	inch	mm	inch	
SOT-89	12	8 ± 0.1	0.315 ± 0.004	178	7	1,000
				330	13	4,000

Marking information

" 2SB1424*U " = Part No. (" * " = hFE grouping Code)

" YM " = Date Code Marking

" Y " = Year

" M " = Month

Font type: Arial

