

1N4148WT-AH

Silicon Epitaxial Planar Switching Diode

Features

- Fast switching speed
- Ultra-small surface mount package
- For general purpose switching applications
- AEC-Q101 Qualified
- Halogen and Antimony Free(HAF), RoHS compliant

PINNING

PIN	DESCRIPTION
1	Cathode
2	Anode

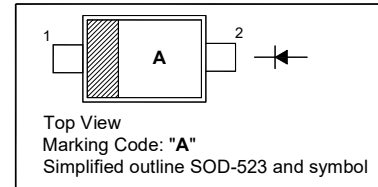

Absolute Maximum Ratings ($T_a = 25\text{ }^\circ\text{C}$)

Parameter	Symbol	Value	Unit
Non-Repetitive Peak Reverse Voltage	V_{RM}	100	V
Reverse Voltage	V_R	75	V
Average Rectified Forward Current	$I_{F(AV)}$	125	mA
Forward Continuous Current	I_{FM}	250	mA
Non-repetitive Peak Forward Surge Current at $t = 1\text{ }\mu\text{s}$ at $t = 100\text{ ms}$	I_{FSM}	2 1	A
Power Dissipation	P_{tot}	150	mW
Operating Temperature Range	T_j	- 65 to + 150	$^\circ\text{C}$
Storage Temperature Range	T_{stg}	- 65 to + 150	$^\circ\text{C}$

Thermal Characteristics

Parameter	Symbol	Max.	Unit
Thermal Resistance from Junction to Ambient ¹⁾	$R_{\theta JA}$	833	$^\circ\text{C/W}$

¹⁾ Device mounted on FR-4 PCB with minimum recommended pad layout.

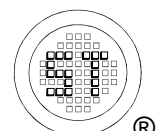

1N4148WT-AH

Characteristics at $T_a = 25\text{ }^\circ\text{C}$

Parameter	Symbol	Min.	Max.	Unit
Reverse Breakdown Voltage at $I_R = 1\text{ }\mu\text{A}$	$V_{(BR)R}$	75	-	V
Forward Voltage at $I_F = 1\text{ mA}$ at $I_F = 10\text{ mA}$ at $I_F = 50\text{ mA}$ at $I_F = 150\text{ mA}$	V_F	- - - -	0.715 0.855 1 1.25	V
Peak Reverse Current at $V_R = 75\text{ V}$ at $V_R = 20\text{ V}$ at $V_R = 75\text{ V}, T_J = 150\text{ }^\circ\text{C}$ at $V_R = 25\text{ V}, T_J = 150\text{ }^\circ\text{C}$	I_R	- - - -	1 25 50 30	μA nA μA μA
Total Capacitance at $V_R = 0\text{ V}, f = 1\text{ MHz}$	C_T	-	2	pF
Reverse Recovery Time at $I_F = 10\text{ mA}, I_{rr} = 0.1 I_R, V_R = 6\text{ V}, R_L = 100\text{ }\Omega$	t_{rr}	-	4	ns

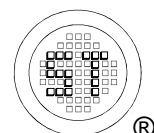

1N4148WT-AH

Electrical characteristic curve

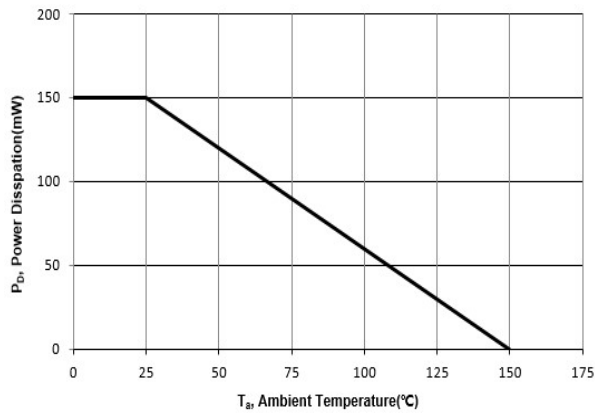

Fig 1. Power Derating Curve

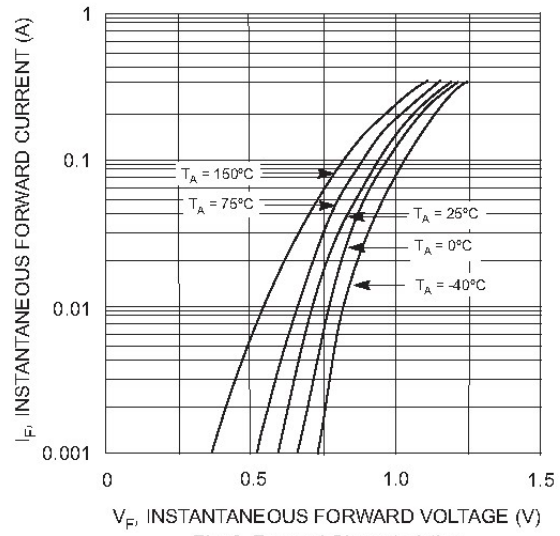

Fig. 2 Forward Characteristics

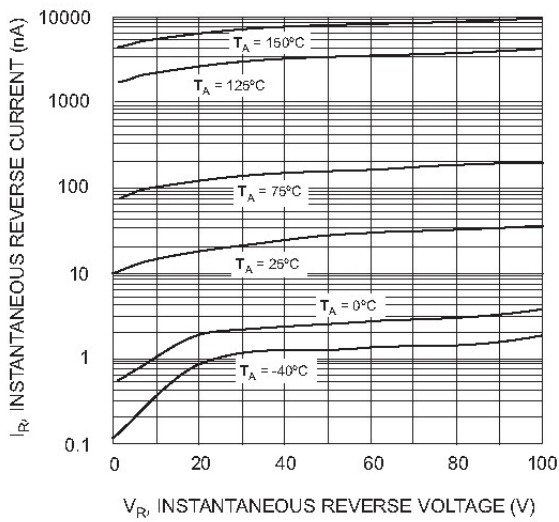

Fig. 3 Typical Reverse Characteristics

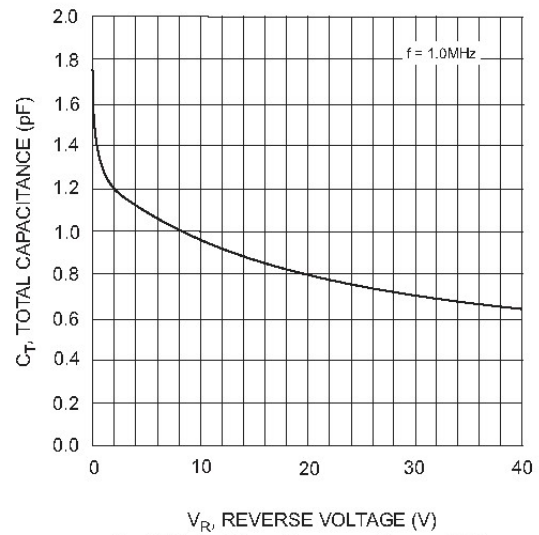
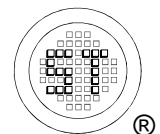

Fig. 4 Typical Capacitance vs. Reverse Voltage



1N4148WT-AH

PACKAGE OUTLINE Plastic surface mounted package

SOD-523

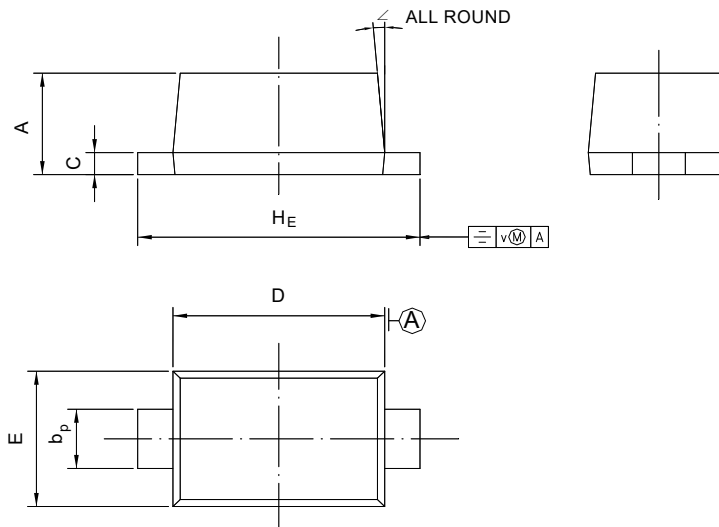

UNIT	A	b _p	C	D	E	H _E	V	∠
mm	0.70 0.60	0.4 0.3	0.135 0.100	1.25 1.15	0.85 0.75	1.7 1.5	0.1	5°

Recommended Soldering Footprint

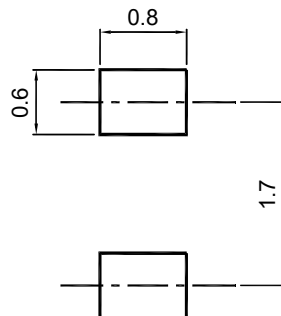

Packing information

Package	Tape Width (mm)	Pitch		Reel Size		Per Reel Packing Quantity
		mm	inch	mm	inch	
SOD-523	8	4 ± 0.1	0.157 ± 0.004	178	7	4,000

Marking information

" III " = Cathode line
 " • " = HAF (Halogen and Antimony Free)
 " A " = Part No.
 Font type: Arial

