

1N4148WS-AH

Silicon Epitaxial Planar Switching Diode

Features

- AEC-Q101 Qualified
- Fast switching
- Halogen and Antimony Free(HAF), RoHS compliant

PINNING

PIN	DESCRIPTION
1	Cathode
2	Anode

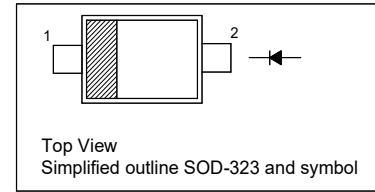

Absolute Maximum Ratings ($T_a = 25^\circ\text{C}$)

Parameter	Symbol	Value	Unit
Peak Reverse Voltage	V_{RM}	100	V
Reverse Voltage	V_R	75	V
Average Rectified Forward Current	$I_{F(AV)}$	150	mA
Forward Continuous Current	I_{FM}	300	mA
Surge Forward Current	I_{FSM}	2 1	A
		at $t < 1 \mu\text{s}$ at $t < 1 \text{s}$	
Power Dissipation	P_D	200	mW
Junction Temperature	T_j	150	$^\circ\text{C}$
Storage Temperature Range	T_{stg}	- 65 to + 150	$^\circ\text{C}$

Thermal Characteristics

Parameter	Symbol	Max.	Unit
Thermal Resistance from Junction to Ambient ¹⁾	$R_{\theta JA}$	625	$^\circ\text{C/W}$

¹⁾ Device mounted on FR-4 substrate PC board, 2oz copper, with minimum recommended pad layout.

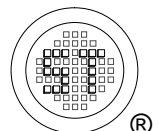

1N4148WS-AH

Characteristics at $T_a = 25^\circ\text{C}$

Parameter	Symbol	Min.	Max.	Unit
Reverse Breakdown Voltage at $I_R = 1 \mu\text{A}$	$V_{(BR)R}$	75	-	V
Forward Voltage at $I_F = 1 \text{ mA}$ at $I_F = 10 \text{ mA}$ at $I_F = 50 \text{ mA}$ at $I_F = 150 \text{ mA}$	V_F	- - - -	0.715 0.855 1 1.25	V
Peak Reverse Current at $V_R = 75 \text{ V}$ at $V_R = 20 \text{ V}$ at $V_R = 75 \text{ V}, T_J = 150^\circ\text{C}$ at $V_R = 25 \text{ V}, T_J = 150^\circ\text{C}$	I_R	- - - -	1 25 50 30	μA nA μA μA
Total Capacitance at $V_R = 0 \text{ V}, f = 1 \text{ MHz}$	C_T	-	2	pF
Reverse Recovery Time at $I_{rr} = 0.1 \times I_R, I_F = 10 \text{ mA}, V_R = 6 \text{ V}, R_L = 100 \Omega$	t_{rr}	-	4	ns

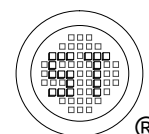

1N4148WS-AH

Electrical Characteristics Curves

Fig 1. Power Derating Curve

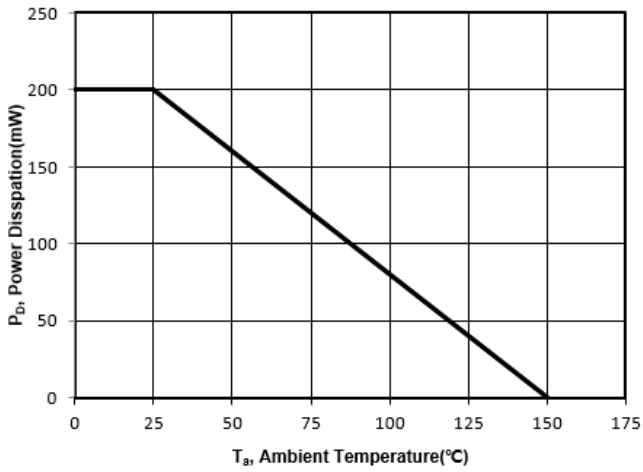

Fig 2. Capacitance Characteristics

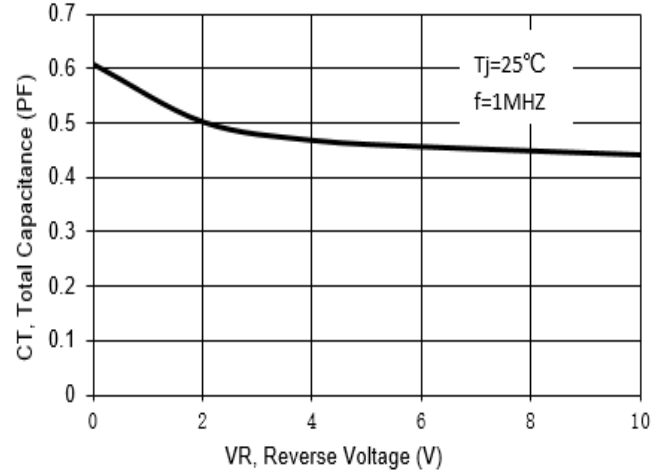

Fig 3. Reverse Characteristics

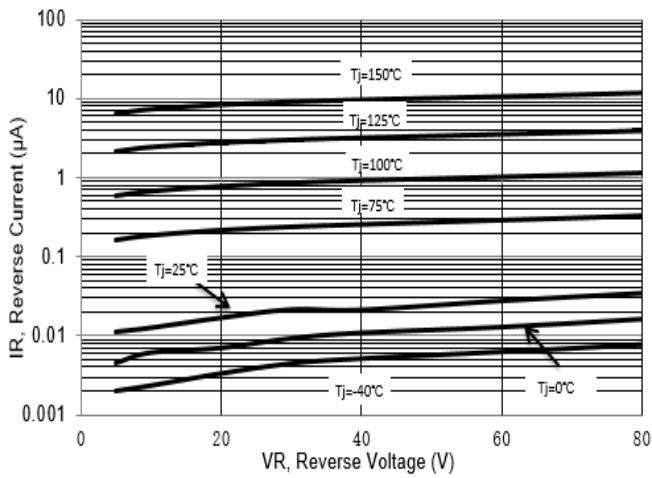
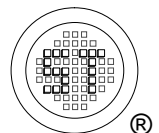
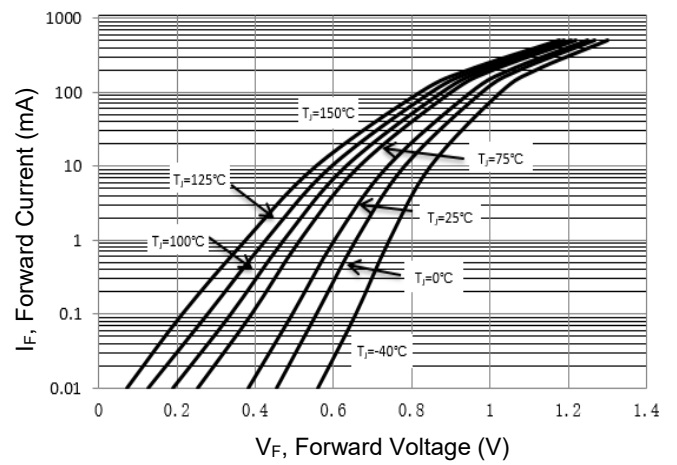

Fig 4. Forward Characteristics



1N4148WS-AH

PACKAGE OUTLINE

Plastic surface mounted package; 2 leads

SOD-323

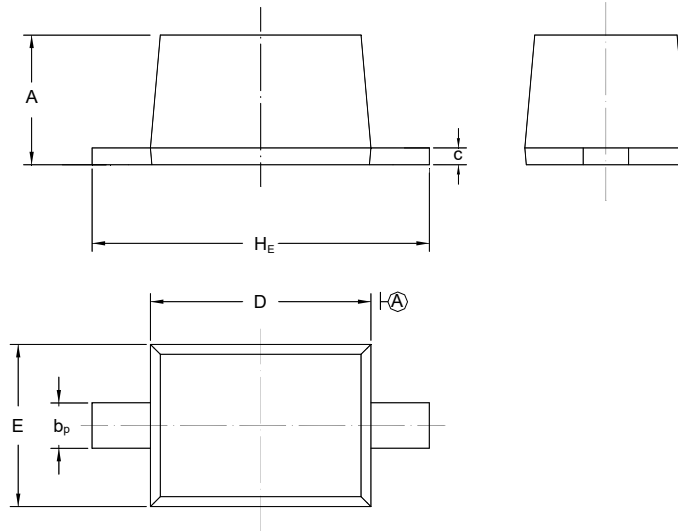

UNIT	A	b _p	C	D	E	H _E
mm	1.10 0.80	0.40 0.25	0.15 0.10	1.80 1.60	1.35 1.15	2.80 2.30

Recommended Soldering Footprint

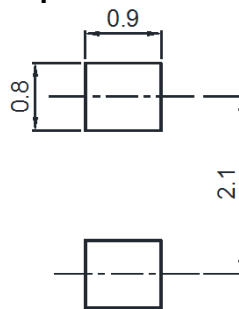

Packing information

Package	Tape Width (mm)	Pitch		Reel Size		Per Reel Packing Quantity
		mm	inch	mm	inch	
SOD-323	8	4 ± 0.1	0.157 ± 0.004	178	7	3,000

Marking information

" W2 " = Part No
 " III " = Cathode line
 " • " = HAF (Halogen and Antimony Free)
 Font type: Arial

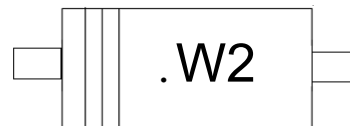

Disclaimer: Our company reserve the right to make modifications, enhancements, improvements, corrections or other changes to improve product design, functions and reliability, anytime without notice. Semtech Electronics Limited makes no warranties, representations or warranties regarding the suitability of its products for any particular purpose, and does not accept any liability arising from the application or use of any product or circuit such as: Apply to medical, military, aircraft, space or life support equipment and expressly waive any and all liability, including but not limited to special, consequential or collateral damage.

